

MTL5500 range

Isolating interface units

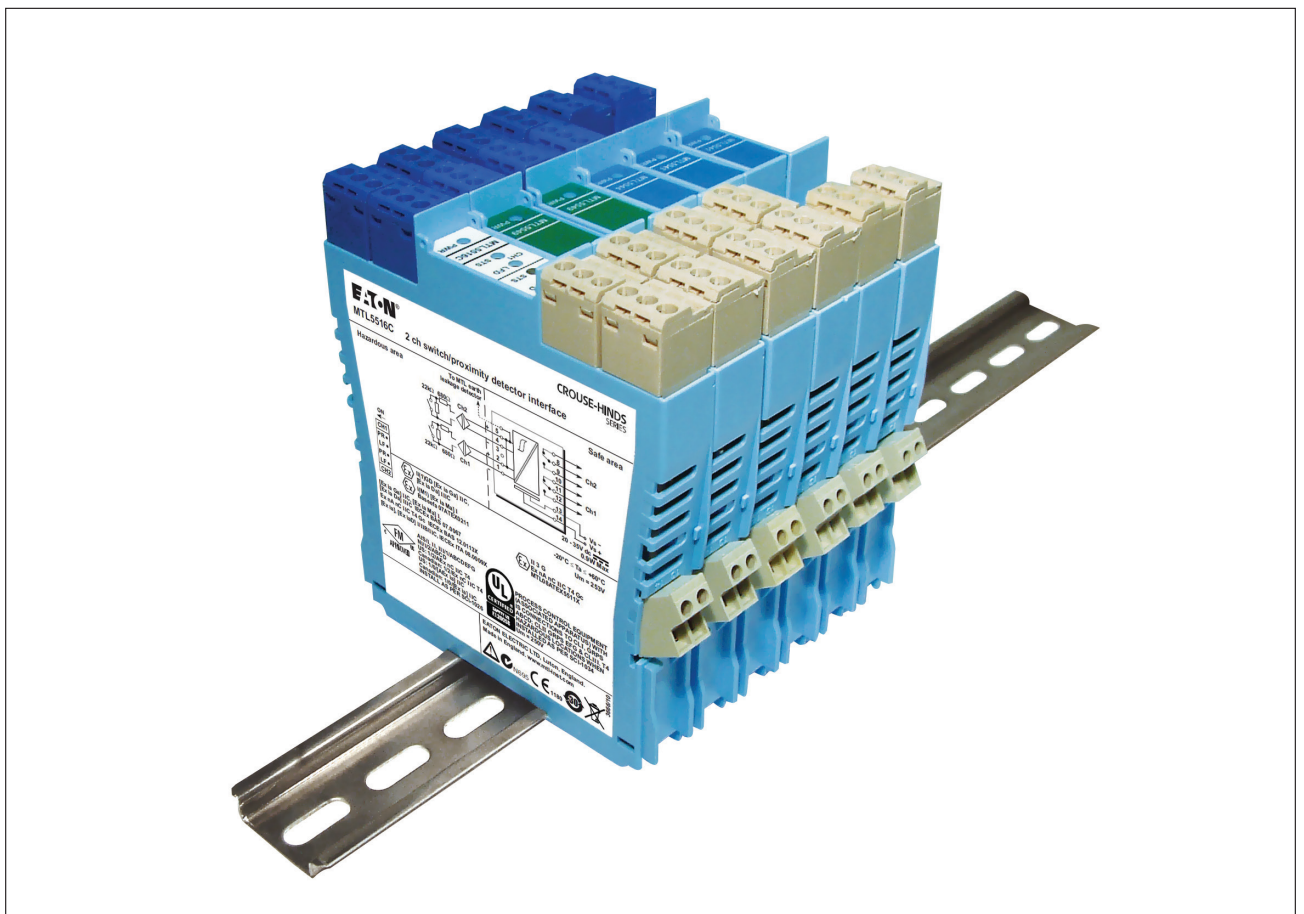

DECLARATION OF CONFORMITY

A printed version of the Declaration of Conformity has been provided separately within the original shipment of goods. However, you can find a copy of the latest version at:
<http://www.mtl-inst.com/certificates>

CONTENTS

	DECLARATION OF CONFORMITY	II
	IMPORTANT NOTE	V
	ATEX SAFETY INSTRUCTIONS	VI
1	INTRODUCTION	1
2	DESCRIPTION	1
3	INSTALLATION	2
3.1	Modules – pre-installation	3
3.2	Installing columns of isolators	4
4	ACCESSORIES	6
4.1	MTL5500 power bus - Installation and use	6
4.2	MPA5500 AC power adaptor	7
4.3	Earth rail and tagging accessories	8
5	DX ENCLOSURES	12
5.1	Environmental conditions	12
5.2	Mounting	16
5.3	Accessories in enclosures	17
5.4	IS warning label	17
6	UNIT DESCRIPTIONS, SETTING-UP AND CONNECTIONS	18
6.1	Digital Input modules	19
6.1.1	Phase reversal	19
6.1.2	Line-Fault Detection (LFD)	19
6.1.3	MTL5501-SR- Fail-safe Switch/Proximity detector interface	20
6.1.4	MTL5510 & MTL5510B- Switch/Proximity detector interface	21
6.1.5	MTL5511- Switch/Proximity detector interface	25
6.1.6	MTL5513- Switch/Proximity detector interface	26
6.1.7	MTL5514/ MTL5514D- Switch/Proximity detector interface	27
6.1.8	MTL5516C- Switch/Proximity detector interface	28
6.1.9	MTL5517- Switch/Proximity detector interface	29
6.2	Digital Output modules	30
6.2.1	MTL5521- Solenoid Alarm driver	30
6.2.2	MTL5522- Solenoid Alarm driver	31
6.2.3	MTL5523- Solenoid Alarm driver	32
6.2.4	MTL5523V/MTL5523VL- Solenoid Alarm driver	33
6.2.5	MTL5524- Solenoid Alarm driver	34
6.2.6	MTL5525- Solenoid Alarm driver	35
6.2.7	MTL5526- Switch Operated Relay	36
6.3	Pulse and Vibration modules	37
6.3.1	MTL5531- Vibration Transducer Interface	37
6.3.2	MTL5532- Pulse Isolator	38
6.3.3	MTL5533- Vibration Transducer Interface	40
6.4	Analogue Input modules	41
6.4.1	MTL5541/MTL5541S- Repeater Power Supply	41
6.4.2	MTL5541A/MTL5541AS- Repeater Power Supply	42
6.4.3	MTL5544/MTL5544S- Repeater Power Supply	43
6.4.4	MTL5544A/MTL5544AS- Current Repeater	44
6.4.5	MTL5544D- Repeater Power Supply	45
6.5	Analogue Output modules	46

(continued on next page)

6.5.1	MTL5546/MTL5546Y- Isolating Driver	46
6.5.2	MTL5549/ MTL5549Y- Isolating Driver	47
6.6	Fire and Smoke Interface modules	48
6.6.1	MTL5561- Fire and Smoke Detector Interface	48
6.7	Temperature Input module	49
6.7.1	MTL5573- Temperature Converter	50
6.7.2	MTL5575- Temperature Converter	51
6.7.3	MTL5576-RTD- Temperature Converter	52
6.7.4	MTL5576-THC- Temperature Converter	53
6.7.5	MTL5581- mV/Thermocouple Isolator	54
6.7.6	MTL5582- mV/Resistance Isolator	55
6.8	General modules	56
6.8.1	MTL5599- Dummy Isolator	56
6.8.2	MTL5991- 24V dc power supply	57
6.9	PCS45/PCL45USB configurator for MTL temperature converters	58
7	FAULT FINDING AND ROUTINE MAINTENANCE	59
7.1	Maintenance precautions	59
7.2	Fault finding	59
7.3	Routine maintenance	59
8	BENCH TESTING MODULES	60
8.1	Digital Input (DI) modules	60
8.2	Digital Output (DO) modules	61
8.3	Analogue Input (AI) Modules	62
8.4	Analogue Output (AO) Modules	65
8.5	Testing the functioning of other modules	65
9	APPLICATIONS INVOLVING ZONE 2 AND/OR ZONE 22 HAZARDOUS AREAS	66
9.1	Enclosure	66
10	APPENDIX 1	67
10.1	MTL5000	67
10.2	MTL5018AC- Switch/proximity detector	68
10.3	MTL5051 serial data comms isolator	70
10.4	MTL5314 trip amplifier for 2- or 3- wire transmitters	73
11	APPENDIX 2	76
11.1	Table A - Safety descriptions	76
11.2	Table B - Maximum cable parameters- IIC gas group	76
11.3	Table C - Maximum cable parameters- IIB gas group	76

IMPORTANT NOTE

 WARNING	<p style="text-align: center;">WARNING</p> <p style="text-align: center;">This manual has content describing the use and installation of safety equipment. This equipment must be installed, operated and maintained only by trained competent personnel and in accordance with all appropriate international, national and local standard codes of practice and site regulations for intrinsically safe apparatus and in accordance with the instructions contained here.</p>
-----------------------------------------------------------------------------------------------------	---------------------------------------------------------------------------------------------------------------------------------------------------------------------------------------------------------------------------------------------------------------------------------------------------------------------------------------------------------------------------------------------------------------------------------------------------------------------------------------

ATEX

If the country of installation is governed by the Essential Health and Safety Requirements (Annex II) of the EU Directive 2014/34/EU [the ATEX Directive - safety of apparatus] then consult the ATEX safety instructions for safe use in this manual before installation.

Note: Refer to the website for multiple language safety instructions.

ELECTRICAL PARAMETERS

Refer to the certification documentation for the electrical rating of these products.

CERTIFICATION DOCUMENTATION

Our website <http://www.mtl-inst.com> contains product documentation regarding intrinsic safety certification for many locations around the world. Consult this data for information relevant to your local certifying authority.

FUNCTIONAL SAFETY

If the MTL5500 range of products are to be used in functional safety applications check that each module has been assessed for that service and refer to the Safety Manual for details.

REPAIR

MTL5500 range of products MUST NOT be repaired. Faulty or damaged products must be replaced with an equivalent certified product.

Symbols used on the product and in this manual



**CAUTION -
Read the instructions**



**CAUTION -
Hot surface**

ATEX SAFETY INSTRUCTIONS

The following information is in accordance with the Essential Health and Safety Requirements (Annex II) of the EU Directive 2014/34/EU [the ATEX Directive - safety of apparatus] and is provided for those locations where the ATEX Directive is applicable.

General

- a) This equipment must only be installed, operated and maintained by competent personnel. Such personnel shall have undergone training, which included instruction on the various types of protection and installation practices, the relevant rules and regulations, and on the general principles of area classification. Appropriate refresher training shall be given on a regular basis. [See clause 4.2 of EN 60079-17].
- b) This equipment has been designed to provide protection against all the relevant additional hazards referred to in Annex II of the directive, such as those in clause 1.2.7.
- c) This equipment has been designed to meet the requirements of EN 60079-15.

Installation

- a) The installation must comply with the appropriate European, national and local regulations, which may include reference to the IEC code of practice IEC 60079-14. In addition, particular industries or end users may have specific requirements relating to the safety of their installations and these requirements should also be met. For the majority of installations the Directive 1999/92/EC [the ATEX Directive - safety of installations] is also applicable.
- b) This apparatus is an associated electrical apparatus and is normally mounted in a non-hazardous [safe] area. Specific apparatus described as Category 3 compliant may be installed in a Zone 2 location providing that the relevant installation conditions are met. When mounted in a Zone 2 location the apparatus must be provided with an enclosure, which offers an additional degree of protection appropriate to the area classification.
- c) Unless already protected by design, this equipment must be protected by a suitable enclosure against:
 - i) mechanical and thermal stresses in excess of those noted in the certification documentation and the product specification
 - ii) aggressive substances, excessive dust, moisture and other contaminants.

Read also the Special Conditions for Safe Use (below) for any additional or more specific information.

Special Conditions of Safe Use for Zone 2 applications

- a) When used in Zone 2, the equipment must be installed in an enclosure or an environment that provides a degree of protection of at least IP54 and meets the relevant material and environmental requirements of EN 60079-0:2012 and EN 60079-15:2010.
- b) The equipment must not be inserted or removed unless either:
 - i) the area in which the equipment is installed is known to be non-hazardous or
 - ii) the circuit to which it is connected has been de-energised.
- c) The 24V supply for this equipment must be derived from a regulated power supply complying with the requirements of European Community Directives.
- d) For 5511, 5514, 5514D, 5516C, 5517, 5526 & 5532 only: Relay contacts may switch up to 35V, 2A and 100VA.
For 5575: Relay contacts may switch up to 35V, 250mA.
- e) For 5573 Maximum Input/Output parameters – see certificate

Inspection and maintenance

- Inspection and maintenance should be carried out in accordance with European, national and local regulations which may refer to the IEC standard IEC 60079-17. In addition specific industries or end users may have specific requirements which should also be met.
- Access to the internal circuitry must not be made during operation.

Repair

- This product cannot be repaired by the user and must be replaced with an equivalent certified product.

Marking

Each device is marked in compliance with the Directive and CE marked with the Notified Body Identification Number.

This information applies to MTL5500 products manufactured during or after the year 2015.

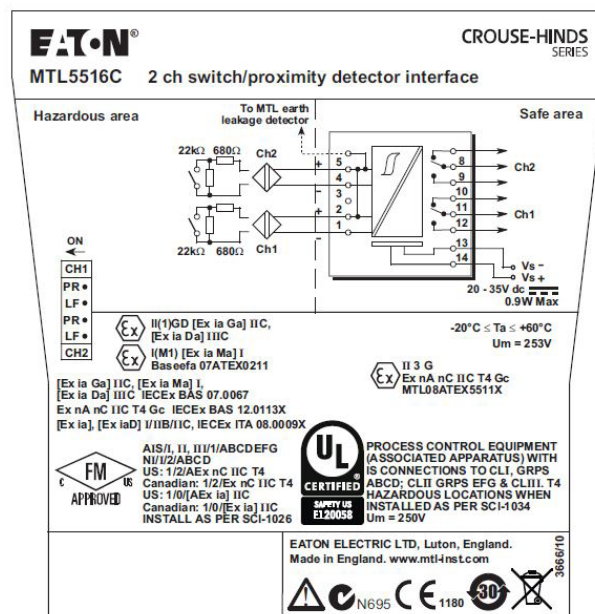

This page is left intentionally blank

1 INTRODUCTION

This instruction manual describes the procedures for installing, connecting, checking and maintaining MTL5500 range of isolating interfaces and accessories. The MTL5500 products provide a DIN-rail mounted, intrinsically safe interface to hazardous areas of a process plant.

The individual sections of this manual cover the following topics

- Section 2 describes the range
- Section 3 specifies precautions both before and during installation
- Section 4 describes mounting accessories and the power adaptor
- Section 5 discusses the DX range of enclosures
- Section 6 provides relevant technical data
- Section 7 outlines fault-finding and maintenance procedures
- Section 8 describes bench test procedure
- Section 9 provides hazardous-area application information
- Section 10 provides MTL5000 products information
- Section 11 provides safety parameter information

2 DESCRIPTION

MTL5500 range of isolators provide intrinsically safe (IS) communication and signal conditioning for a wide range of hazardous-area devices. Total AC and DC isolation exists between input, output and power supply on separately powered units, and between input and output on loop-powered units. No IS earth is required. DIN-rail mounting and plug-in signal and power connectors simplify installation and maintenance. Units are powered from a 20 to 35V DC supply, or, in some cases, from the signal itself.

Our latest generation of IS interfaces utilises an innovative “One-Core” technology to ensure the highest quality and availability while maintaining maximum flexibility at lowest cost. Incorporating advanced circuit design, a common set of components and innovative isolating transformer construction, they achieve a significant reduction in power consumption while increasing channel packing densities. The compact, 16mm wide design reduces weight and gives exceptionally high packing density. They build on the proven success of the MTL2000, 3000, 4000 and 5000 ranges to bring the benefits of new developments in galvanic isolation without compromising the reliability of the designs from which they have evolved.

The backplane mounting MTL4500 range is designed with system vendors in mind for “project-focussed” applications such as Distributed Control System (DCS), Emergency Shutdown Systems (ESD) and Fire and Gas monitoring (F&G).

The DIN-rail mounting MTL5500 range meets the needs of the IS interface market for “application focussed” projects, ranging from single instrument loops, through to fully equipped cabinets, across all industries where hazardous areas exist.

Both new ranges have been designed for compatibility with earlier models. The MTL4500 range provides plug-replacements for earlier MTL4000 range of units, while the MTL5500 models can easily replace MTL5000 range of units. Each offer the latest in modern technology and efficiency without compromise.

In addition to their use in IS circuits, specific models within the MTL4500 and MTL5500 ranges have been assessed and approved for use in Functional Safety applications. These have been verified under the certified Functional Safety Management (FSM) programme implemented by us.

The table below lists the modules in the MTL5500 range. Refer also to the individual MTL5500 range of data sheets.

Digital Input	Channels	Function
MTL5501-SR	1	fail-safe, solid-state output + LFD alarm
MTL5510	4	switch/prox input, solid-state output
MTL5510B	4	multi-function, switch/prox input, solid-state output
MTL5511	1	switch/prox input, c/o relay output
MTL5513	2	switch/prox input, solid-state output
MTL5514	1	switch/prox input, relay + LFD
MTL5514D	1	switch/prox input, dual relay output
MTL5516C	2	switch/prox input, relay + LFD outputs
MTL5517	2	switch/prox input, c/o relay + LFD outputs
Digital Output		
MTL5521	1	loop-powered solenoid driver
MTL5522	1	loop-powered solenoid driver, IIB
MTL5523	1	solenoid driver with LFD
MTL5523V	1	solenoid driver with LFD + voltage control, IIC
MTL5523VL	1	solenoid driver with LFD + voltage control, IIC
MTL5524	1	switch operated solenoid driver
MTL5525	1	switch operated solenoid driver, low power
MTL5526	2	switch operated relay
Pulse & Vibration Output		
MTL5531	1	vibration probe interface
MTL5532	1	pulse isolator, digital or analogue output
MTL5533	2	vibration probe interface
Analogue Input		
MTL5541	1	2/3 wire transmitter repeater
MTL5541A	1	transmitter repeater, passive input
MTL5541AS	1	transmitter repeater, passive input, current sink
MTL5541S	1	2/3 wire transmitter repeater, current sink
MTL5544	2	2/3 wire transmitter repeater
MTL5544A	2	transmitter repeater, passive input
MTL5544AS	2	transmitter repeater, passive input, current sink
MTL5544S	2	2/3 wire transmitter repeater, current sink
MTL5544D	1	2/3 wire transmitter repeater, dual output
Analogue Output		
MTL5546	1	4-20mA smart isolating driver + LFD
MTL5546Y	1	4-20mA smart isolating driver + oc LFD
MTL5549	2	4-20mA smart isolating driver + LFD
MTL5549Y	2	4-20mA smart isolating driver + oc LFD
Fire and Smoke		
MTL5561	2	loop-powered for fire & smoke detectors
Temperature Input		
MTL5573	1	temperature converter, THC or RTD
MTL5575	1	temperature converter, THC or RTD
MTL5576-RTD	2	temperature converter, RTD
MTL5576-THC	2	temperature converter, THC
MTL5581	1	mV/thermocouple isolator for low level signals
MTL5582	1	mV/resistance isolator to repeat RTD signals
General		
MTL5599	1	dummy module

3 INSTALLATION

Important

- Make sure that all installation work is carried out in accordance with all relevant local standards, codes of practice and site regulations.
- When planning the installation of MTL5500 range of isolators it is essential to **make sure that intrinsically safe and non-intrinsically safe wiring is segregated**, and that units are installed as required by a nationally accepted authority or as described in EN 60079-14, ISA RP 12.6 or DIN VDE-165.
- External power supply shall contain double isolation from hazardous voltages or that unit shall be supplied by Limited Power Circuit per UL/IEC 60950 or Limited Energy Circuit per UL/IEC 61010 or Class II Power Supply per NEC.
- Environmental conditions: indoor use, altitude (up to 2000m) and humidity less than 95% non condensing.
- Check that the hazardous-area equipment complies with the descriptive system document.
- If in doubt, refer to the certificate/catalogue for clarification of any aspects of intrinsic safety or contact Eaton's MTL product line or your local representative for assistance.
- Make sure the correct hazardous-area connector (field-wiring plug) is plugged into the corresponding isolator. It is recommended that the connector is identified by the same tag number as the matching isolator.

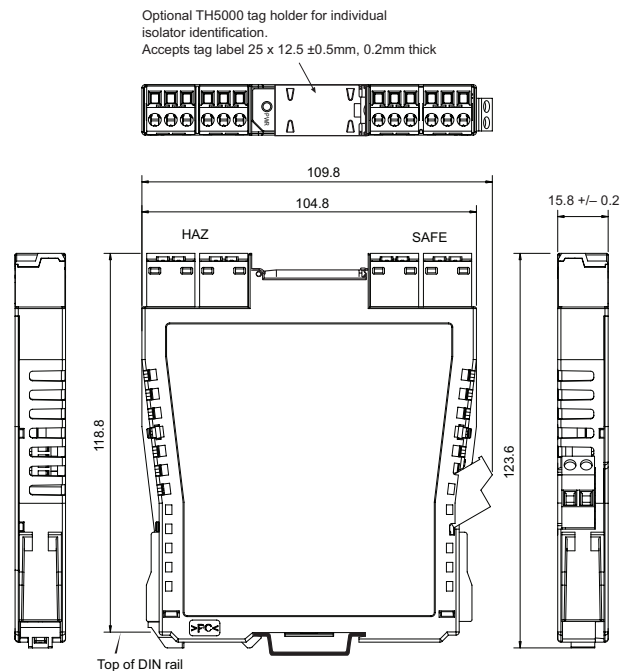

Figure 3.1: Dimensions of MTL5500 package

Mount all MTL5500 range of isolators on low-profile (7mm) or high-profile (15mm) type T35 (top-hat) DIN-rail to EN50022, BS5584, DIN46277. This is available from Eaton, in 1 metre lengths (**THR2**- DIN rail). Install isolators within the safe area unless they are enclosed in approved flameproof, pressurised or purged enclosures and ensure that the local environment is clean and free of dirt and dust. Note the ambient temperature considerations of section 3.1.4.

It is recommended that, in normal practice, the DIN rail should be earthed/grounded to ensure the safety of personnel in the event of a.c. mains (line) power being applied accidentally to the rail.

3.1 Modules – pre-installation

3.1.1 Switch settings for operating conditions

Some modules have operating conditions, such as Line-Fault Detection (LFD), Phase Reversal, etc., that can be established by the setting of switches on the unit. The subminiature switches are accessible through an aperture on the side of the module (see Figure 3.2) and can be set in the required positions with, for example, the blade of a small screwdriver.

The switch setting options are always indicated on the side label of the module, but the user may also consult the individual module information in Section 6 of this manual for details.

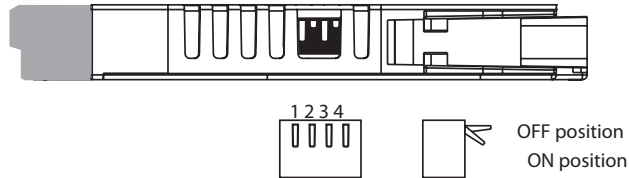

Figure 3.2: Location of switches

3.1.2 Relay outputs

Reactive loads on all units with relays should be adequately suppressed. To achieve maximum contact life on all *mechanical* output relays, the load should not be less than 50mW, e.g. 10mA at $\geq 5V$ DC.

3.1.3 Earth leakage detection

An MTL4220 earth leakage detector can be used with a number of MTL5500 range of units to detect hazardous-area earth faults which can then be rectified without needing to shut down the loop ('no-fail' operation).

Note: If the hazardous area signal plug fitted does not have a screw terminal in position 3 then part number 'HAZ1-3' can be ordered and fitted to use this function.

3.1.4 Ambient temperature considerations

Ambient temperature limits for unenclosed MTL5500 range of isolators are from -20°C to $+60^{\circ}\text{C}$ with units close-packed, unless otherwise specified.

3.2 Installing columns of isolators

On new installations, if isolators are mounted in several rows or columns, mount alternate rows or columns so that units face in opposite directions. This allows safe- and hazardous-area wiring looms to be shared. See Figure 3.1 for isolator dimensions.

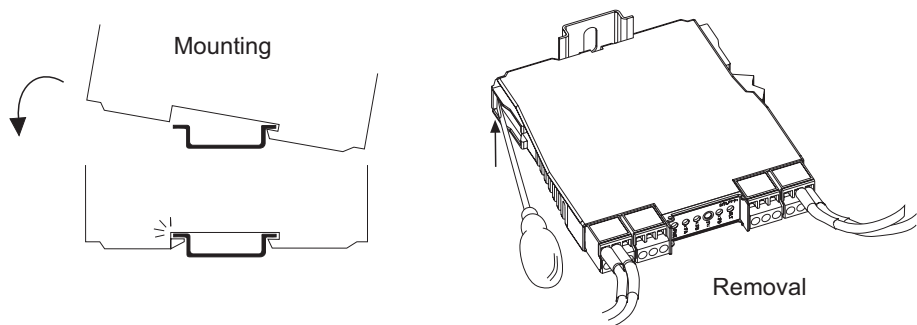

3.2.1 Mounting isolators on DIN rail

Figure 3.3: DIN rail mounting and removal of isolators

Clip an isolator onto the DIN rail as shown in Figure 3.3, with the blue signal plugs facing towards the hazardous-area. To remove an isolator from the rail, insert a screwdriver blade (2.5- 5.0mm diam.) into the clip as shown. This will release the clip so that the isolator may be pivoted off the rail- there is no need to lever the clip. Allow a maximum mounting pitch of 16.2mm for each unit.

3.2.2 Wiring up isolators

Each unit is supplied with the appropriate number and type of safe- and hazardous-area connectors (see Figure 3.4), as dictated by the terminals used and the type of power supply.

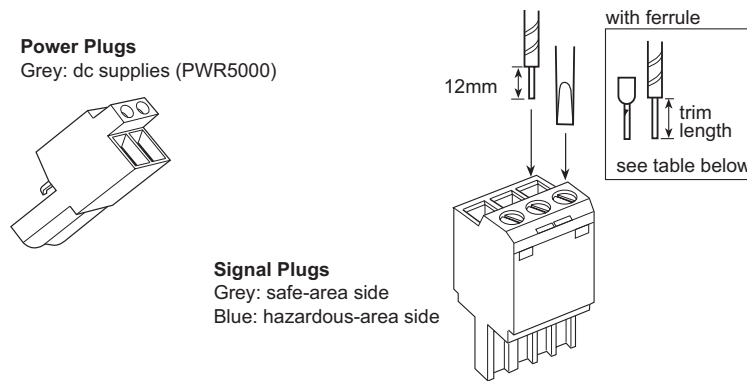

Figure 3.4: Removable power and signal plugs

Note: Earth Leakage Detection requires the use of hazardous area connector type HAZ1-3, which may need to be ordered separately. See datasheet for ordering information.

Loop-powered devices do not require power connectors. Depending on the installation, it may be easier to wire up isolators with power and signal plugs either in place or removed. Either way, allow sufficient free cable to permit plugs to be removed easily for future maintenance and/or replacement purposes. See Section 6 for instructions on wiring individual modules.

3.2.2.1 Signal and power conductors

Removable signal and power plugs are fitted with screw clamp terminals. Note that the conductors should be between 14 and 24 AWG (1.6 and 0.5mm diam.) in size. Signal plugs, located on top of the modules, are mechanically keyed to fit in only one position. They are coloured grey, for safe-area connections, and blue, for hazardous-area connections.

For externally powered units, a power plug slots into the socket at terminals 13 and 14 on the safe-area side of each module. The socket is coloured black if the unit is dc powered. Power plugs are coloured grey, for plugging into the black sockets of dc powered units.

3.2.2.2 Making connections

- Trim back the insulation of conductors by 12mm.
- Check the terminal assignments shown in section 6 or on the side label of the unit.
- Insert conductors according to the terminal assignments and tighten screws.

If the wires are to be fitted with crimp ferrules, the following is a list of those recommended with required trim lengths for each:

Plug type	Entry	Wire size (mm ²)	Metal tube length (mm)	Trim length	Recommended ferrules
Signal	Single	0.75	12	14	Weidmuller 902591
Signal	Single	1.0	12	14	Cembre PKC112
Signal	Single	1.0	12	14	Phoenix Contact AI 1-12 RD (3200674)
Signal	Single	1.5	12	14	Cembre PKE1518†
Signal	Single	2.5	12	14	Cembre PKE2518†
Power	Twin	2x0.75	10	12	Cembre PKET7510
Power	Twin	2x0.75	10	12	AMP (non-preferred) 966144-5
Power	Twin	2x1.0	10	12	Phoenix Contact AI-TWIN 2X 1-10 RD
Power	Single	0.75	10	12	AMP 966067-0
Power	Single	1.0	10	12	Phoenix Contact AI 1-10 RD

TABLE 3.1: Crimp Ferrule Options

† These ferrules with 18mm length metal tubes should be cut to 12mm after crimping

Note: Smaller section wire than that stated can often be successfully used if the crimping is good.

Crimp tool: Phoenix Contact Crimpfox UD6 part number 1204436

3.2.2.3 Finishing

Wire up individual isolators in accordance with wiring schedules. Daisy-chain power supply connections between individual power plugs or use the power bus (see section 4.1).

Segregate hazardous- and safe-area wiring into separate trunking or looms wherever possible to avoid errors and maintain a tidy installation.

Use an MTL5599 dummy isolator to provide termination and earthing for unused cores from the hazardous area.

4 ACCESSORIES

4.1 MTL5500 power bus - Installation and use

4.1.1 MTL5500 range power bus

A power bus kit enables power supply terminals (13 and 14) of up to 32 installed MTL5500 range of units to be linked to a standard 24V power supply. The bus consists of a chain of power plugs and different lengths are available to suit various numbers of modules as follows.

Number of modules	Kit ID code <i>(contains grey power plugs for 24V dc supply)</i>
1 to 8	PB-8T
9 to 16	PB-16T
17 to 24	PB-24T
25 to 32	PB-32T

Table 4.1: Power bus kit options

4.1.2 Installation

1. Check to make sure the bus length is correct for the number of modules involved.
2. If the number of modules is less than the maximum number the chain will support, cut off the surplus power plugs at the tail end of the chain- leaving sufficient cable to attach further power plugs if it becomes necessary later.
3. Insert power plugs into the power terminals on the safe- area side of each module in sequence.
4. Connect the power supply source to the tail end of the chain (using the insulation displacement connectors [Scotchlocks] provided if required).

Notes:

1. To avoid excessive voltage drop or over-current, DO NOT connect power buses in .
2. Surplus sections can be used (and, if required) connected together provided the cut ends are safely terminated and/or connected together. Use single ferrules with a crimp tool or insulation displacement connectors (Scotchlocks). Suitable ferrules and connectors are provided with the kits.

Figure 4.1: Power bus wiring, joining and terminating

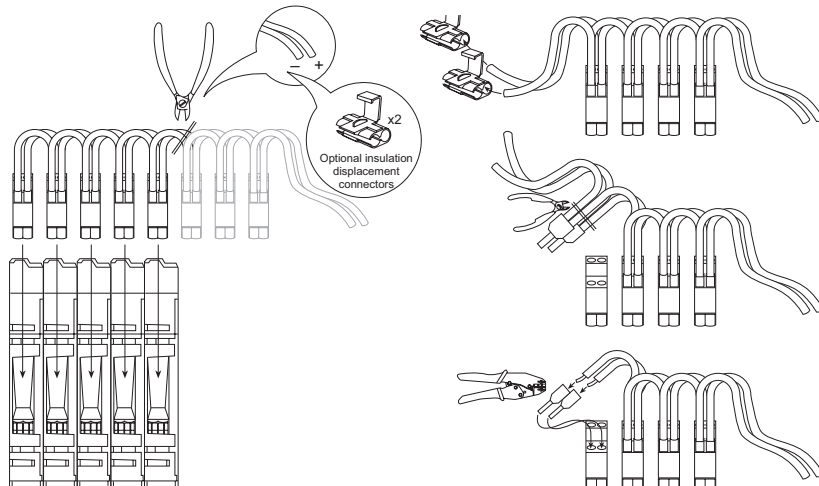

4.2 MPA5500 AC power adaptor

When only one or two MTL5500 modules are required for a particular application, it may be desirable to power the units from the AC mains supply directly, rather than use a separate DC supply unit. The MPA5500 is an adaptor that plugs into the DC power socket on the side edge of an MTL5500 module and clips securely onto the module housing. Its 25V DC power output is sufficient to supply a single module and can be connected to any normal ac power source.

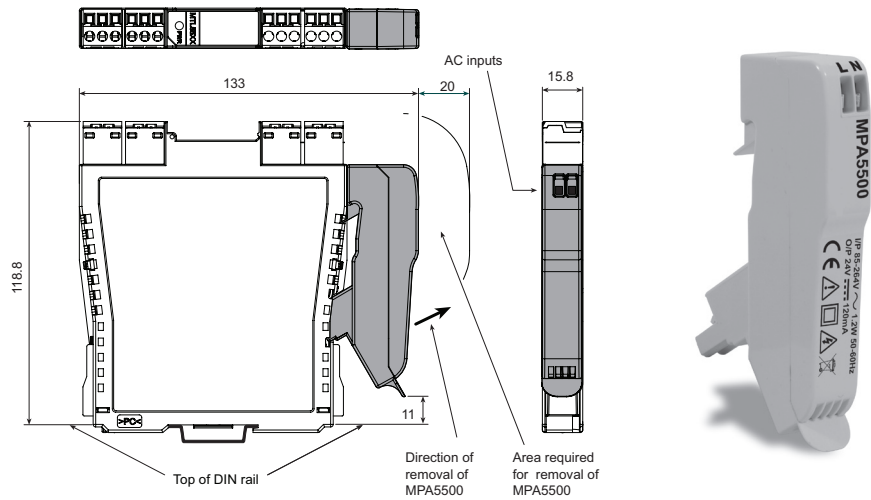



Figure 4.2: MPA5500 AC power adaptor

To fit the adaptor, locate the tongue of the adaptor into the top slot on the side of the MTL5500 module and press the adaptor until it fits closely to the body of the module, as shown.

Use double-insulated AC power cable with conductor parameters of 0.2–1.5mm², or 0.25–1.5mm² if using ferrules. Strip the outer insulation by no more than 30mm, then strip the inner conductors by 8mm. Insert the cables appropriately in the cage-clamp connectors marked 'L' and 'N'.

The incoming AC power must have some form of power disconnection device, such as a switch or circuit breaker; a coupler that can be disconnected without the use of a tool; or a separable plug, without a locking device, to mate with an adjacent socket outlet.

In addition, some form of cable anchorage must be used to relieve the cable conductors from strain, including twisting, where they connect to the adaptor, and which will also protect the insulation of the cable from abrasion.

 <p>WARNING</p>	<p>WARNING</p> <p>This adaptor is not suitable for use with MTL5000 range of modules.</p>
-----------------------------------------------------------------------------------------------------------	--------------------------------------------------------------------------------------------------

4.3 Earth rail and tagging accessories

This section explains how to specify and assemble earth rail and tagging strip accessories for the MTL5500 range.

The accessories consist of mounting brackets, earth rails, tagging strips and associated parts. They provide facilities for earthing, terminating cable screens and tagging (identifying) the positions of individual units.

4.3.1 Parts list

IMB57 Insulating mounting block (Figures 4.3, 4.4 & 4.5)

One required at each end of a tagging strip/earth rail. Suitable for low-profile (7.5mm) and high-profile (15mm) symmetrical DIN rail.

ERB57S Earth-rail bracket, straight (figure 4.3, 4.4 & 4.9)

Nickel-plated bus bar; supplied with two push fasteners, one earth-rail clamp (14mm, 35mm²) and one earth cable clamp (10mm, 16mm²).

Note: ERB57S is the preferred choice of earth-rail bracket. It is usually fitted in the upper slot on insulating mounting block IMB57.

*Where the earth rail is required to be positioned at a lower height and to allow access to the IMB57 mounting screws, the straight earth-rail bracket ERB57S can be inserted in the lower slot, but only **after** insulating mounting blocks IMB57 are clamped to the DIN rail. This may not be possible if, for example, trunking is fitted. In this case, fit offset earth-rail bracket ERB570 (see figure 4.4 & 4.10) in the upper slot: the mounting blocks can then be fitted in a restricted space with this bracket already fitted.*

ERB570 Earth-rail bracket, offset (figure 4.9)

Nickel-plated bus bar; supplied with two push fasteners, one earth-rail clamp (14mm, 35mm²) and one earth cable clamp (10mm, 16mm²).

ERL7 Earth rail, 1m length (figure 4.9)

Nickel-plated bus bar; may be cut to length.

TAG57 Tagging strip, 1m length (figure 4.3, 4.4 & 4.6)

Cut to size. Supplied with tagging strip label.

TGL57 Tagging strip labels, set of 10 x 0.5m (figure 4.3 & 4.4)

Spares replacement, for use with TAG57 tagging strip.

MS010 DIN rail module spacer, 10mm, pack of 5 (figure 4.7)

Grey spacer; Used to provide 10mm air-circulation space between modules, if necessary.

ETM7 Earth terminal, bag of 50 (figure 4.8)

For terminating cable screens and 0V returns on the ERL7 earth rail. For cables $\geq 4\text{mm}^2$.

TH5000 Tag holder

Spares replacement.

Connectors (Figure 4.5)

Spares replacement: HAZ1-3, HAZ4-6, HAZ-CJC, PWR5000, SAF7-9, SAF10-12 (SAF1-3 and SAF4-6 grey connectors, also available for use in safe-area applications).

4.3.2 Assembly

4.3.2.1 Fitting earth rails

a) In upper position

Before fitting insulating mounting blocks IMB57, check that the swing nuts in the base of each unit are turned back into the moulding. Locate the mounting blocks on the DIN rail in the chosen position and tighten the screws (see figure 4.10). Check that the swing nuts rotate correctly to locate underneath the flanges of the DIN rail.

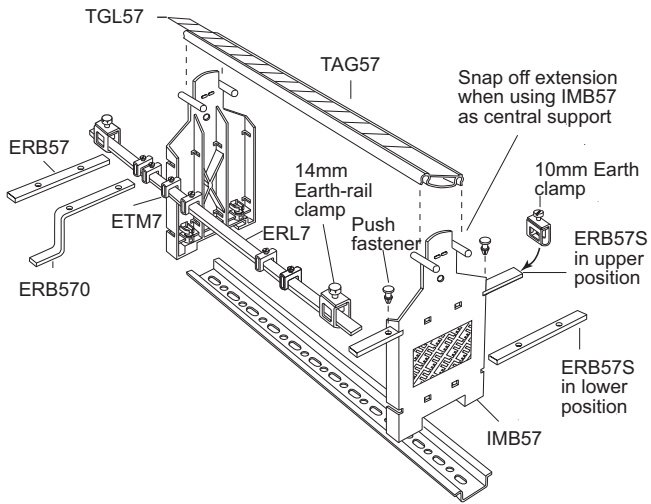

Figure 4.3: Assembly drawing showing part numbers

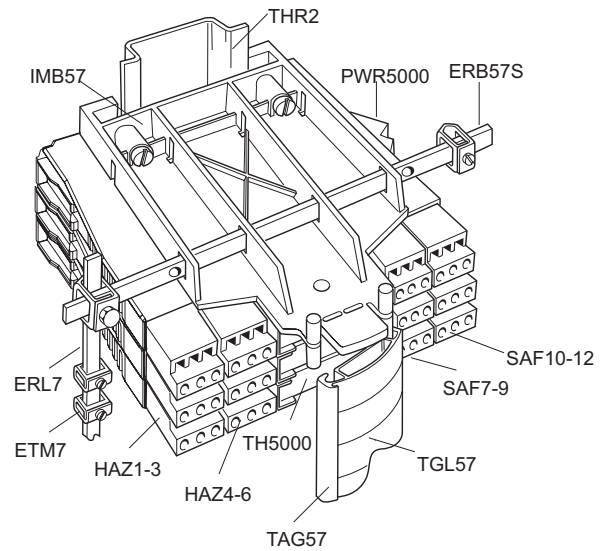

Figure 4.4: Mounting details

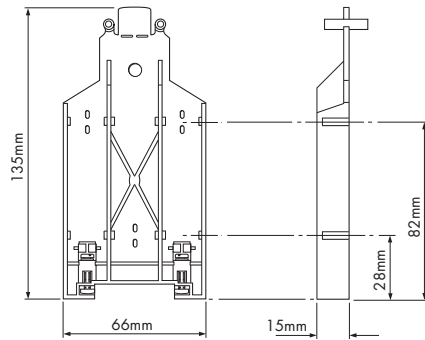

Figure 4.5: IMB57 Insulating mounting block

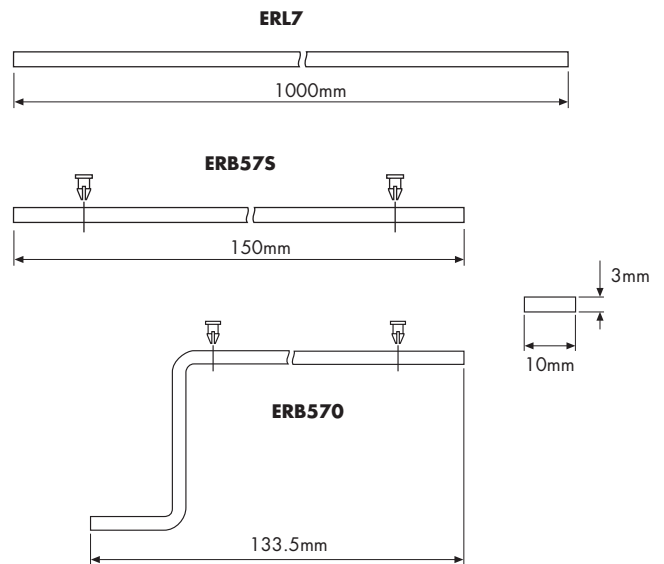

Figure 4.6: TAG57 Tagging strip, 1m length



Figure 4.7: MS010 DIN rail module spacers

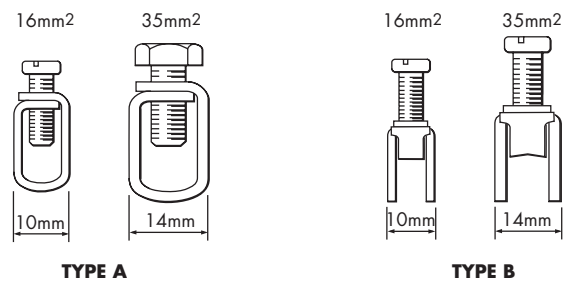

Figure 4.9: Earth rails and clamps

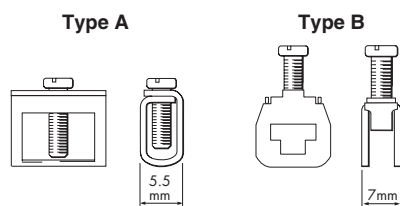

Figure 4.8: ETM7 Earth terminals

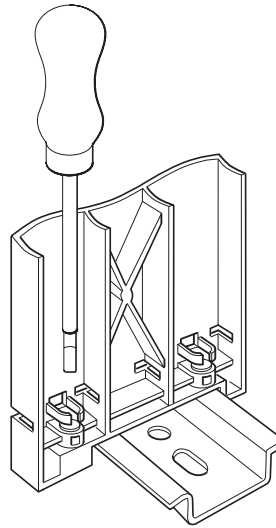

Figure 4.10: Fitting IMB57

Slide a straight earth-rail bracket ERB57S into the upper slot in each mounting block. Push two plastic push fasteners into each bracket to locate the brackets in the mounting blocks.

Cut earth rail ERL7 to the length needed. Slide the required number of ETM7 earth terminals (5mm or 7mm wide) onto the rail. Clamp each end of the earth rail to earth-rail brackets ERB57S using the terminal clamps (14mm, 35mm²) supplied. Fit an earth clamp (10mm, 16mm²) to the free end of each earth-rail bracket.

Note: For lengths of earth-rail greater than 500mm, provide additional support by installing a third IMB57 mounting block and earth-rail bracket, mid-way between the end mounting blocks. Snap out the perforated extension between the lugs on this mounting block if a continuous tagging strip is to be fitted (see figure 4.6).

b) In lower position, where at least 150mm clearance exists on one side, measured from the edge of the mounting block.

As for *a)*, but slide earth-rail brackets ERB57S into the lower slots in each mounting block.

c) In lower position, where there is insufficient clearance to fit earth-rail brackets ERB57S.

As for *a)*, but slide offset earth-rail brackets ERB57O into the upper slot in each mounting block before assembling the mounting blocks to the DIN rail. ERB57S brackets cannot be used because they obscure the fixing screws on the mounting blocks.

4.3.2.2 Fitting tagging strips

Assemble mounting blocks IMB57 to the DIN rail as above. Cut TAG57 tagging strip and label to the length needed, and insert label so that the appropriate side is visible. Clip the strip onto the lugs on the mounting blocks. Hinge up the strip to provide access to the tops of the isolators.

Note: If necessary, provide additional support for long lengths of tagging strip by installing an extra IMB57 mounting block mid-way between the end mounting blocks. Snap out the perforated extension between the lugs on this mounting block.

4.3.3 Completed assemblies

Figure 4.11 illustrates a complete assembly of MTL5500 isolators using the accessories mentioned above.

The broken-line boxes either side of the assembly represent cable trunking, and the accompanying dimensions represent the recommended minimum spacing between the trunking and the module assemblies.

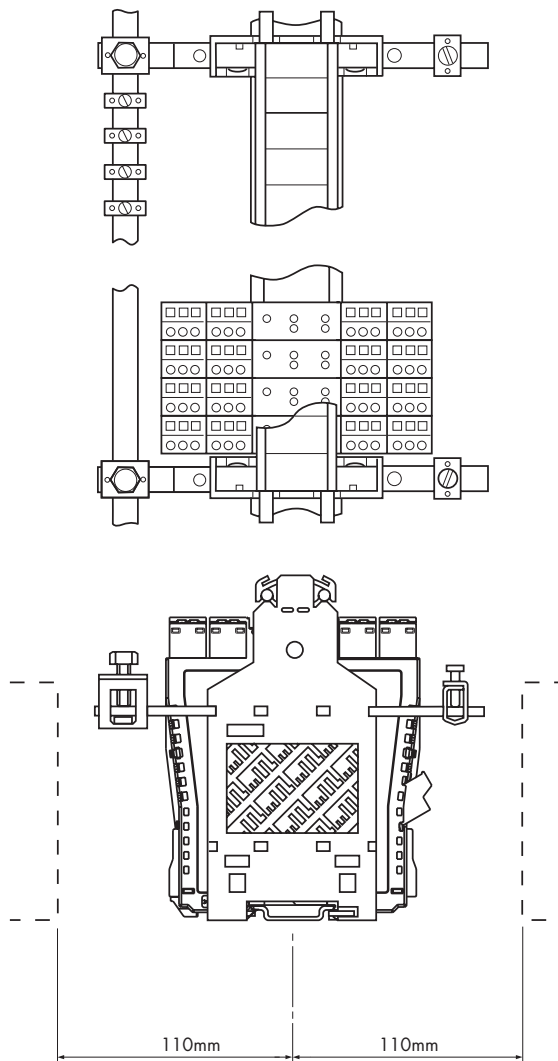

Figure 4.11: MTL5500 complete assembly

Colour	Module no.	Function
Yellow	MTL5501-SR	Digital Inputs
White	MTL551x	
Red	MTL552x	Digital Outputs
Blue	MTL5531/33	Vibration
Purple	MTL5532	Pulse
Blue	MTL5541x MTL5544x	Analogue Inputs
Green	MTL5546x MTL5549x	Analogue Outputs
Blue	MTL556x	Fire & Smoke
Orange	MTL557x MTL558x	Temperature inputs
Grey	MTL5599	Dummy isolator

Table 4.2: MTL5500 front label colour coding

5 DX ENCLOSURES

Enclosures are usually selected on the basis of the number of units they will accommodate and Table 5.1 shows the capacity of each of the enclosures. Figure 5.2 shows each type of enclosure containing MTL5500 modules.

Table 5.1: DX range of enclosures- module capacities

Enclosure	Number of MTL5500 isolators <i>16mm mounting pitch</i>
DX070	4 (2*)
DX170	10 (8*)
(DX430)	26 (24*) no longer available

* Use these figures when two IMB57 mounting brackets for tagging/earth-rail accessories are included.

Note: The user should be aware that some workshop preparation may be required for the cable gland plates before the enclosure is ready for on-site installation.

5.1 Environmental conditions

Environmental conditions that should be taken into account when installing DX enclosures include:-

	See section
Maximum ambient temperature limits	5.1.1
Storage temperatures	5.1.2
Humidity	5.1.3
Corrosion resistance	5.1.4
Flammability	5.1.5
Impact resistance	5.1.6
Chemical resistance	5.1.7

5.1.1 Maximum outside enclosure temperature limits

Figure 5.1: Graph depicting outside enclosure temperature limits for DX enclosures used with MTL5500 isolators

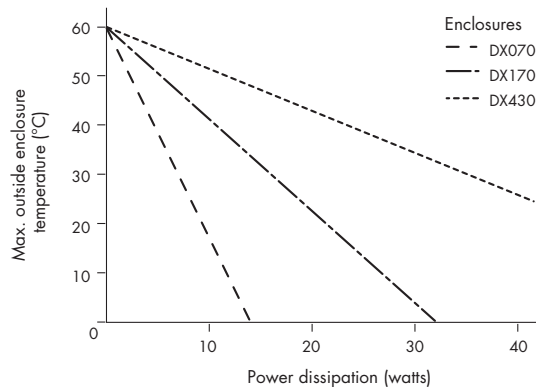

The maximum outside enclosure temperature depends upon the total power dissipated by the installed modules which, in turn, depends upon their number and type. It can also be influenced by the Authority whose standards may need to be applied to the system, e.g. Baseefa, Factory Mutual Research Corporation, Canadian Standards Association.

Figure 5.1 shows, in graphical form, the maximum outside enclosure temperatures (T_{MO}) for given levels of power dissipation.

The graph was derived from the following equation and should be used to calculate accurately the suitability of any particular mix of modules.

$$T_{MO} = 60^{\circ}\text{C} - \partial T \quad \text{where } \partial T = k_1 \times P$$

P = total power (watts) dissipated by modules in an enclosure

k_1 = is a dissipation constant for a given enclosure and module. Select the relevant value from Table 5.2.

(60°C is the temperature inside the enclosure)

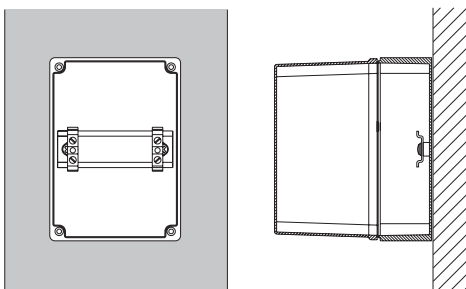

Figure 5.3: Optimum orientation for wall mounted enclosure

	DX070	DX170
MTL5500	4.03	1.88

Table 5.2: Dissipation constant k_1 for enclosures ($^{\circ}\text{C}/\text{watt}$)

Orientation of the enclosures is also important- the optimum position being on a vertical surface with the internal DIN-rail horizontal as shown in Figure 5.3. Any other position can reduce the maximum allowable ambient temperature by up to 5°C .

Examples

Tables 5.3 and 5.4 list likely combinations of MTL5500 modules in the three enclosure types and indicate the acceptable maximum permitted outside enclosure temperature for these based on the graph in Figure 5.1. See the specifications included in the datasheets for the power dissipation figures of individual MTL5500 modules.

Table 5.3: Typical mix of MTL5500 modules

Enclosure	Modules installed	Power dissipation of modules in watts (P)	Maximum outside enclosure temp. (T_{MO}) $^{\circ}\text{C}$
DX070	2 x MTL5511 + 2 x MTL5544	$(2 \times 0.72) + (2 \times 1.4) = 4.24$	42.9
DX170	5 x MTL5511 + 5 x MTL5544	$(5 \times 0.72) + (5 \times 1.4) = 10.6$	40.1

Table 5.4: Power versus maximum outside enclosure temperature

Enclosure	Number of installed modules	k $^{\circ}\text{C}/\text{watt}$	Power dissipation of modules in watts (P)	Maximum outside enclosure temp. (T_{MO}) $^{\circ}\text{C}$
DX070	4	4.03	4.0	43.9
	4	4.03	6.0	35.8
DX170	10	1.88	10.0	41.2
	10	1.88	15.0	31.8

5.1.2 Storage temperatures

Storage temperatures are safe within the range -40°C to $+80^{\circ}\text{C}$.

5.1.3 Humidity limits

Safe humidity limits are within the range 5 to 95% RH.

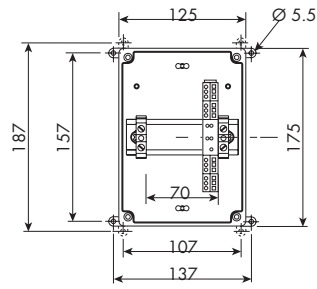

DX070

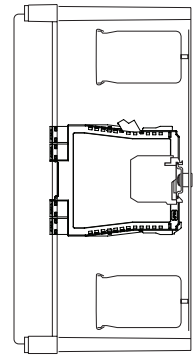
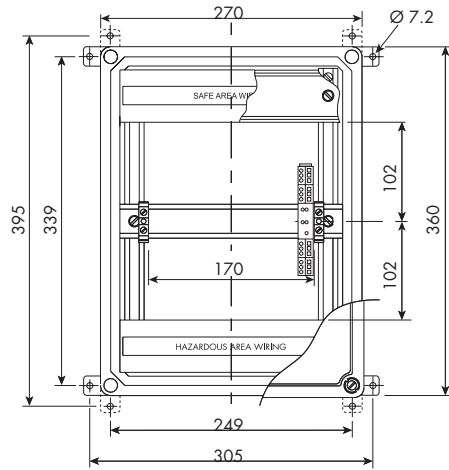
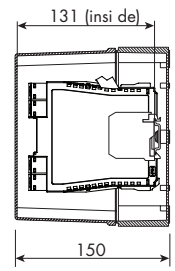

DX170

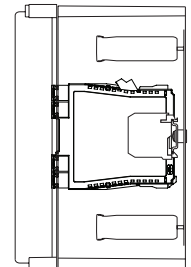
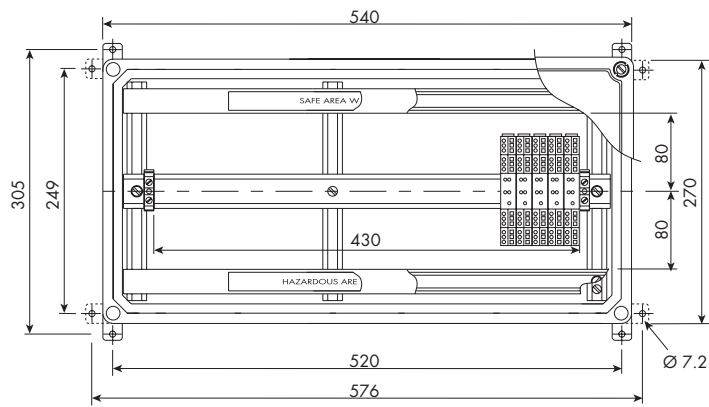
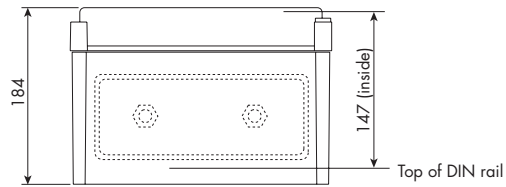

DX430

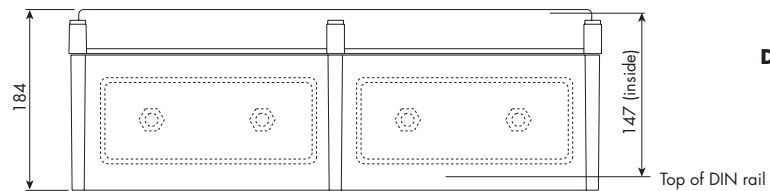

n.b.
DX430
no longer
available

Figure 5.2: DX range of enclosures

5.1.4 Corrosion resistance

The effect of corrosion on DX enclosures is negligible.

5.1.5 Flammability rating

The flammable properties of the materials used in the construction of the enclosures are well understood by manufacturers and ratings have been established to a number of standards. One of the better known standards is the Underwriter's Laboratory standard UL 94 and the ratings for the enclosure materials are given as:

Materials	UL94 rating
Polycarbonate (all lids)	V2/V0
Polycarbonate with glass reinforcement (DX070 base)	V1/V0
Polyester with glass reinforcement (DX170 & DX430 bases)	V0

Items made from similar materials are well established as suitable for use in process I/O marshalling areas.

5.1.6 Impact resistance

The enclosure designs have been tested to an impact resistance of greater than 2 Joules which exceeds the BS EN 61010-1 requirements of 0.5 Joules.

5.1.7 Chemical resistance

The overall chemical resistance of the enclosures is limited by the resistance of the transparent polycarbonate lid. The glass-reinforced polycarbonate/polyester (GRP) bases have a higher resistance than plain polycarbonate. Table 5.5 lists qualitative evaluations of resistance to a variety of chemical agents.

Table 5.5: Qualitative evaluations of resistance to various chemical agents

Chemical agents	Qualitative evaluation of resistance
Salt water; neutral salts; acids (low concentrations); hydraulic oil	Excellent
Alcohols	Very good
Acids (high concentrations); alkalis (low concentrations); petrol; cooling fluids	Good
Alkalis (high concentrations); solvents.	Poor

5.2 Mounting

5.2.1 General

These instructions are concerned solely with mounting the DX enclosures. Instructions for wiring and testing individual modules within the enclosures are provided in Section 6.

Sufficient space is provided within the enclosures to accommodate tagging and earth-rail accessories but this is at the expense of a reduction in the number of modules that can be fitted.

5.2.2 Location and orientation

5.2.2.1 Location

The DX enclosures are intended for safe (non-hazardous) area use.

The enclosures are rated NEMA 4X; consequently, in N. America or Canada, assuming the modules have the required approvals, they can be used in Class 1, Division 2 (gases) location, but check with local requirements and ensure all cable entries also conform. In this case, an additional warning label will be required on or near the enclosure warning that the MTL5500 interfaces must not be removed unless the area is known to be non-hazardous. The enclosures are NOT suitable for Class II or III, Division 2 hazardous locations.

5.2.2.2 Orientation

As noted earlier (see section 5.1.1), for optimum temperature performance the enclosures should be mounted on a vertical surface with the internal DIN rail horizontal.

5.2.3 Mounting details

See Figure 5.2 for the dimensions and mounting hole distances, etc., of the three DX enclosures. The recommended method of mounting-described here-uses the four wall-mounting lugs supplied with each enclosure. An alternative method of mounting is by direct attachment to the mounting surface through the corner holes.

Note: When the wall-mounting lugs are used to attach the enclosures, the overall depth of the enclosure is increased by an additional 3.3 mm (DX070) or 7 mm (DX170 and DX430).

- a) At each of the four corner fixing holes, insert one of the screws provided and use it to attach a fixing lug to the base of the enclosure.
- b) Each lug can be used in one of two positions as shown in Figure 5.2.
- c) Attach the lugs to the mounting surface with suitable fasteners.
- d) Diameters of fixing holes in lugs are 5.5mm (DX070) and 7.0mm (DX170 and DX430)
- e) Appropriate fixing hole distances are shown in Figures 5.2.

5.2.4 Cable glanding

All cables into the enclosures must be glanded to IP65 standards to maintain this rating for the enclosure as a whole. Cable glands and gland plates are not supplied. Glanding requirements vary for each enclosure as follows:

DX070

On the DX070, 'knockout' holes are provided, in two different sizes (15.5 mm and 21 mm), on the side faces of the base. See Table 5.7 for recommended cable glands.

DX170

The DX170 can accommodate one gland plate on each side- see figure 5.2 for details. Table 5.6 lists suppliers of suitable gland plate kits and Table 5.7 lists recommended glands.

Table 5.6: Recommended gland plate kits for the DX170 and DX430 enclosures.

Manufacturer/agent	Manufacturer's part number
	Enclosure DX170
Hellermann Tyton	TL27/360
Sarel	21128

Table 5.7: Recommended cable glands for use with DX enclosures.

Gland thread size	Cable sizes (mm)	Gland plate hole size (mm)	Weidmuller part nos.		Sarel part nos.	
			Gland	Locknut	Gland	Locknut
PG9	5 to 8	15.2	951891	952216	08871	08881
PG13,5	8 to 13	20.4	951893	952218	08873	08883

Weidmuller (UK) <http://www.weidmuller.co.uk>

Sarel (UK) <http://www.sarel.co.uk>

Hellermann Tyton (UK) <http://www.hellermantyton.co.uk>

5.3 Accessories in enclosures

Apart from mounting, there are some other installation details which should be considered before adding the appropriate interface modules and making the necessary cabling connections.

A range of accessories is available to accompany the MTL5500 units (see section 4) and the following points should be observed.

5.3.1 Insulating mounting block (IMB57)

A pair of these can be attached to the DIN rail, at either end of the modules, to provide a mounting for earth rails. Use of mounting blocks will reduce the space available for isolator modules.

5.3.2 Earth rails (ERL7)

Earth rail is produced in 1 metre lengths and will require cutting to length before mounting. ERL7 earth rails can be mounted either side of the modules but are typically mounted on the hazardous side of the DIN rail.

5.3.3 Tagging strip (TAG57 and TGL57)

Tagging strip is produced in 1 metre lengths and will require cutting to length before mounting. Similarly, the labels will require cutting to fit the tagging strip.

5.4 IS warning label

A 'Take Care' IS warning label is provided inside each enclosure. This should be attached to the inside of the transparent lid when its orientation has been established.

6 UNIT DESCRIPTIONS, SETTING-UP AND CONNECTIONS

This section describes the function (briefly), the setting-up procedure and the wiring connections for each MTL5500 unit. For a fuller functional description and a detailed technical specification, refer to the individual datasheets, which can be found on our website at <http://www.mtl-inst.com> or in the current MTL IS catalogue.

If a fault is suspected, first check that the power LED is lit (not applicable to loop-powered devices). If necessary, check that all signal and power plugs are properly inserted, that no wires are loose and that the unit is mounted correctly. If operation is still suspect, the unit should be replaced with a serviceable unit.

There are no replaceable parts inside MTL5500 units, so any that appear to be inoperative should be returned to the manufacturer/supplier for repair or replacement.

 <p>WARNING</p>	<p>WARNING</p> <p>When disconnecting units for maintenance purposes, take care to segregate hazardous and safe-area cables.</p> <ul style="list-style-type: none"> • Short circuit hazardous-area cable cores to an IS earth or insulate and secure the ends. • Insulate and secure safe-area cables. If testing a unit 'in situ' note that the test equipment used MUST be intrinsically safe.
---------------------------------------------------------------------------------------------------------	---------------------------------------------------------------------------------------------------------------------------------------------------------------------------------------------------------------------------------------------------------------------------------------------------------------------------------------------------------------------------------------------------------------------------------------

The rest of this section is divided into sub-sections based upon the type of module, as follows.

- 6.1 Digital Input modules**
MTL5501-SR, MTL5510, MTL5510B, MTL5511, MTL5513, MTL5514, MTL5514D, MTL5516C, MTL5517
- 6.2 Digital Output modules**
MTL5521, MTL5522, MTL5523, MTL5523V, MTL5523VL, MTL5524, MTL5525, MTL5526
- 6-3 Pulse and Vibration modules**
MTL5531, MTL5532, MTL5533
- 6.4 Analogue Input modules**
MTL5541, MTL5541A, MTL5541AS, MTL5541S, MTL5544, MTL5544A, MTL5544AS, MTL5544D, MTL5544S
- 6.5 Analogue Output modules**
MTL5546, MTL5546Y, MTL5549, MTL5549Y
- 6.5 Fire and Smoke interface modules**
MTL5561
- 6.7 Temperature Input modules**
MTL5573, MTL5575, MTL5576-RTD, MTL5576-THC, MTL5581, MTL5582
- 6.8 General modules**
MTL5599, MTL5991
- 6.9 PCS45/PCL45USB configurator for MTL temperature converters**

Note: Any LED indicator provided on the modules will display in the following colours:

LED label	LED colour
PWR (power)	Green
STS (status)	Yellow
LFD (line fault)	Red
FLT (fault)	Red
OPx (o/p status)	Yellow

6.1 Digital Input modules

The Digital Input (DI) module range offers solid state or relay output switches in a safe area that respond to input switches located in a hazardous area. Single or multiple channel (2 or 4) options are available, as well as **Line-Fault Detection (LFD)**.

Modules with LFD can recognise open or short circuit conditions on the input wires going to the field sensors, and some DI modules have the facility to reverse the effect of the input on the output

i.e. **phase reversal**.

These options are chosen with switches located on the edge of the module on the hazardous area terminal side. In some applications it may be easier to set these switches *before* fitting the module to the DIN-rail.

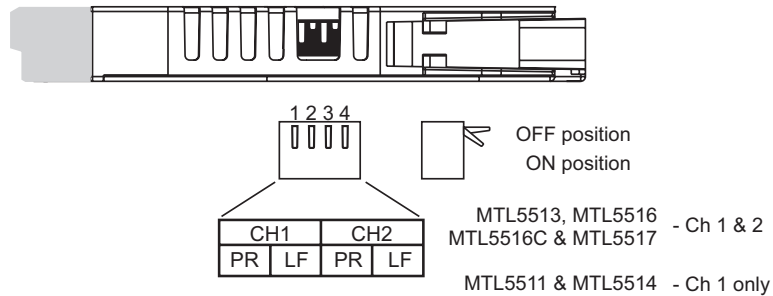

Figure 6.1: Switches to set LFD and phase reversal

6.1.1 Phase reversal

Set the PR switch ON or OFF for the appropriate channel(s).

6.1.2 Line-Fault Detection (LFD)

Where fitted, set the LF switch ON or OFF for the appropriate channel(s). **Note:** LFD is permanently active on the MTL5501-SR.

For all DI modules with LFD **except for the MTL5501-SR**; when using the LFD facility with a contact input, resistors must be used. Fit 500Ω to 1kΩ (preferred value 680Ω) in with the switch and 20kΩ to 25kΩ (preferred value 22kΩ) in parallel with the switch.

For modes of operation of the MTL5510 & MTL5510B that include LFD, resistors should be fitted as described above.

For MTL5501-SR use 1kΩ in and 10kΩ in parallel with switch contact inputs.

For hazardous-area inputs conforming to EN 60947-5-6:2001 (NAMUR), a line fault is judged by the following rules:

- Open circuit condition if hazardous-area current <50μA
- Line integrity (no open circuit) if hazardous-area current >250μA
- Short circuit condition if hazardous-area load <100Ω
- Line integrity (no short circuit) if hazardous-area load >360Ω

Note: the open circuit window (between 250μA and 50μA), and the short circuit window (between 100Ω and 360Ω), is not hysteresis. All MTL5500 modules, with inputs conforming to EN 60947-5-6:2001 (NAMUR), will switch between open and complete circuit conditions within these limits.

The MTL5501-SR LFD relay *de-energises* when a fault condition is detected. The MTL5514 and the MTL5517 *energise* the LFD relay to indicate a fault condition.

6.1.3 MTL5501-SR - Fail-safe Switch/Proximity detector interface

Single channel, fail-safe module with line-fault detection

The MTL5501-SR enables a fail-safe switch/proximity detector located in the hazardous area to control an isolated fail-safe electronic output. It provides line-fault detection (LFD) alarm contacts and is designed for use with approved fail-safe sensors in loops that require operation up to SIL3 according to the functional safety standard IEC 61508.

Note: For reliable, long-term operation the load on the LFD switching relay should be not less than 50mW, e.g. 10mA at 5V DC.

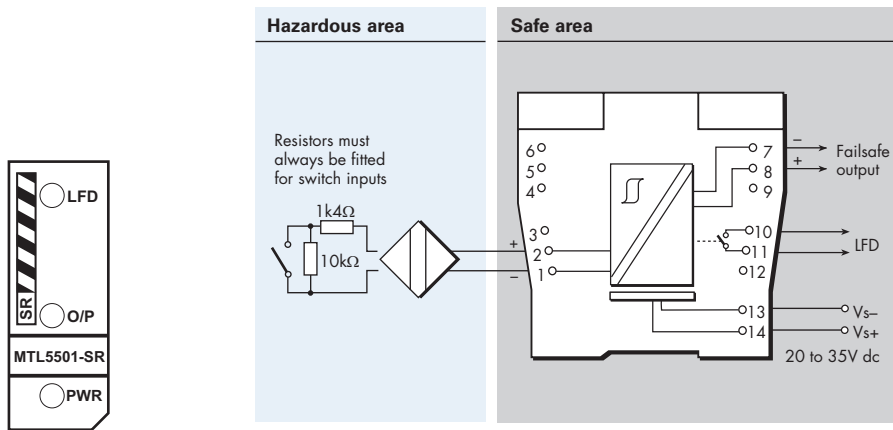

Figure 6.2:
Top label for
MTL5501-SR

Terminal	Function
1	Input -ve
2	Input +ve
7	Output -ve
8	Output +ve
10	LFD
11	LFD
13	Supply -ve
14	Supply +ve

Input / output characteristics

Input value in sensor circuits	Fail-safe output	Operation	LFD contacts
$2.9\text{mA} < I_s < 3.9\text{mA}$	ON	Normal	CLOSED
$I_s < 1.9\text{mA} \ \& \ I_s > 5.1\text{mA}$	OFF	Normal	CLOSED
$I_s < 50\mu\text{A}$	OFF	Broken line	OPEN
$R_s < 100\Omega$	OFF	Shorted line	OPEN

Correct operation of the fail-safe output and LFD is indicated by the LEDs on the front of the unit. The yellow **O/P** LED is ON when the fail-safe output is energised. The red **LFD** LED flashes if a line fault is detected. The fail-safe output is de-energised (OFF) if the module detects an incorrect sensor current, an open circuit or a short circuit in the sensor circuit.

Input signal sensors may be either suitable proximity sensors or switches. The proximity sensor properties are specified in the standard EN60947-5-6:2001; however, when used with MTL5501-SR modules, additional requirements for the "low-impedance" current of $3.4 \pm 0.5\text{mA}$ must be met. The list below shows suitable proximity sensors, all manufactured by Pepperl+Fuchs Group, Germany, and specified as usable to SIL3, according to IEC 61508:

SJ 2-SN	NJ 4-12GK-SN	NJ 10-30GK-SN
SJ 3,5-SN	NJ 5-18GK-SN	NJ 15-30GK-SN
SJ 3,5-S1N	NJ 8-18GK-SN	NJ 6S1+U1+N
NJ 2-11-SN	NJ 6-22-SN	NJ 15S+U1+N
NJ 2-11-SN-G	NJ 6-22-SN-G	NJ 20S+U1+N
NJ 2-12GK-SN	NJ 5-30GK-S1N	NJ 40-FP-SN-P1

6.1.4 MTL5510 & MTL5510B - Switch/Proximity detector interface

4-channel, digital input and multifunction modules

These digital modules provide solid state output switches in a safe area that respond to switches (inputs) located in a hazardous area. The way they respond- their "mode"- can be configured using a bank of four DIL selector switches accessible through the side of the module- see Figure 6.4.

Model MTL5510 has an one output channel for each input channel and the user can reverse the output phase if necessary to suit the application. Model MTL5510B has more varied modes that can, for example, enable one input to affect multiple outputs or create latched outputs, etc.) The channel output transistors- Ch1/Ch2 and Ch3/Ch4- share a common terminal and can switch +ve or -ve polarity signals.

Note that parallel resistors are required for switch inputs with LFD- see Section 6.1.2 for recommended values.

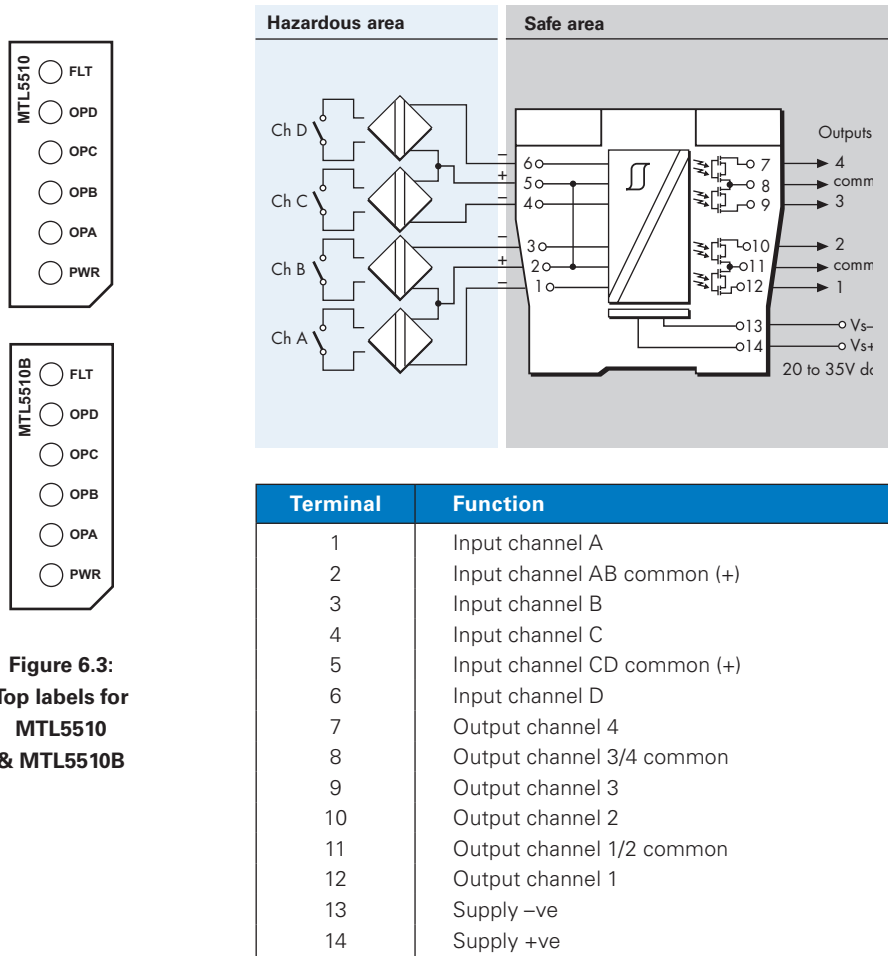

Figure 6.3:
Top labels for
MTL5510
& MTL5510B

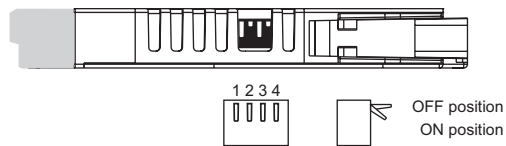

Figure 6.4: DIL switches for setting mode

Tables 6.1 and 6.2 show details of the modes available and the switch settings required to obtain them.

For ease of access, it is recommended that switches are set to the required mode *before* installation.

Table 6.1 indicates whether the output follows the input, or the output is the reverse or antiphase of the input.

For example, in mode 0, o/p 1 = chA; so, if channel A switch is closed, then output 1 will also be closed or short circuit. However, in mode 1, o/p 1 = chA rev., so if channel A switch is closed, then output 1 will be the reverse, i.e. open-circuit.

Table 6.1 - MTL5510 mode options

Switch setting				MODE	o/p 1	o/p 2	o/p 3	o/p 4	i/p type
1	2	3	4						
OFF	OFF	OFF	OFF	0	chA	chB	chC	chD	switch
ON	OFF	OFF	OFF	1	chA rev.	chB	chC	chD	
OFF	ON	OFF	OFF	2	chA	chB rev.	chC	chD	
ON	ON	OFF	OFF	3	chA	chB	chC rev.	chD	
OFF	OFF	ON	OFF	4	chA	chB	chC	chD rev.	
ON	OFF	ON	OFF	5	chA rev.	chB	chC rev.	chD	
OFF	ON	ON	OFF	6	chA	chB rev.	chC	chD rev.	
ON	ON	ON	OFF	7	chA rev.	chB rev.	chC rev.	chD rev.	prox. detector + LFD
OFF	OFF	OFF	ON	8	chA	chB	chC	chD	
ON	OFF	OFF	ON	9	chA rev.	chB	chC	chD	
OFF	ON	OFF	ON	10	chA	chB rev.	chC	chD	
ON	ON	OFF	ON	11	chA	chB	chC rev.	chD	
OFF	OFF	ON	ON	12	chA	chB	chC	chD rev.	
ON	OFF	ON	ON	13	chA rev.	chB	chC rev.	chD	
OFF	ON	ON	ON	14	chA	chB rev.	chC	chD rev.	
ON	ON	ON	ON	15	chA rev.	chB rev.	chC rev.	chD rev.	

Table 6.2 shows the **MTL5510B** modes. The logic tables and timing diagrams on the following pages provide more detailed information on these modes.

Table 6.2 - MTL5510B mode options

Switch settings				MODE	Function	Equivalent
1	2	3	4			
OFF	OFF	OFF	OFF	0	4-ch switch input (see MTL5510 mode 0)	MTL5510
ON	OFF	OFF	OFF	1	2-ch each channel one input, two outputs	
OFF	ON	OFF	OFF	2*	Same as mode 1 with all outputs phase reversed	
ON	ON	OFF	OFF	3	2-ch, 2-pole changeover output	
OFF	OFF	ON	OFF	4	1-ch with line fault output	MTL5014
ON	OFF	ON	OFF	5	As mode 4 with changeover outputs	
OFF	ON	ON	OFF	6	1-ch with start-stop latch	MTL2210B
ON	ON	ON	OFF	7*	As mode 2 with LFD enabled	
OFF	OFF	OFF	ON	8	4-ch switch input, see MTL5510 mode 8	MTL5510
ON	OFF	OFF	ON	9	2-ch with line fault output	MTL5017
OFF	ON	OFF	ON	10	As mode 9 with LFD changeover	
ON	ON	OFF	ON	11	As mode 10 with channel phase reversed	
OFF	OFF	ON	ON	12	3-ch with normally-open LFD output	
ON	OFF	ON	ON	13	3-ch with normally-closed LFD output	
OFF	ON	ON	ON	14	2-ch monostable, pulse stretcher	
ON	ON	ON	ON	15	4-ch switch input, see MTL5510 mode 15	MTL5510

*Mode of operation changed August 2015

MTL5510 & MTL5510B diagnostics

If an internal fault is detected, all outputs and channel LEDs will turn off and the red Fault LED will turn ON.

MTL5510B modes

The following logic and timing diagrams are provided to assist the user in understanding the behaviour of the MTL5510B module when a specific **mode** is chosen.

The open switch (↗) and closed switch (↘) symbols are used to represent both the input conditions of Ch A, Ch B, Ch C or Ch D and then the output conditions of o/p 1, 2, 3 or 4. Note that in certain modes a Line Fault can cause an override of the output.

Mode 1: 2 ch, each ch 1 input 2 outputs

	i/p - Ch A			i/p - Ch C	
	↗	↘		↗	↘
o/p 1	↗	↘		-	-
	-	-	o/p 2	↗	↘
o/p 3	↗	↘		-	-
	-	-	o/p 4	↗	↘

How to use these mode tables - examples

The logic tables for Mode 1 represent Ch A controlling outputs 1 & 3, while Ch C controls outputs 2 & 4.

Output 1 & 3 are shown following input Ch A (open or closed) while Outputs 2 & 4 follow input Ch C.

Mode 2 however shows o/p 1, 2, 3 and 4 being in antiphase to their inputs.

Mode 9 operates with both outputs for each channel being in antiphase to their inputs.

Mode 2: As mode 1 with all outputs phase reversed

	i/p - Ch A			i/p - Ch C	
	↗	↘		↗	↘
o/p 1	↘	↗		-	-
	-	-	o/p 2	↘	↗
o/p 3	↘	↗		-	-
	-	-	o/p 4	↘	↗

Mode 3: 2 ch, 2 pole c/o output

	i/p - Ch A			i/p - Ch C	
	↗	↘		↗	↘
o/p 1	↗	↘		-	-
o/p 2	↘	↗		-	-
	-	-	o/p 3	↗	↘
	-	-	o/p 4	↘	↗

Mode 4: 1 ch with line fault output

	i/p - Ch A			
	↗	↘	↗	↘
	No fault	Line fault	No fault	Line fault
o/p 1	↗	↘	↘	↗
	No fault	Line fault	No fault	Line fault
o/p 3	↘	↗	↗	↘

Mode 5: As mode 4 with c/o outputs

	i/p - Ch A			
	↗	↘	↗	↘
	No fault	Line fault	No fault	Line fault
o/p 1	↗	↘	↘	↗
o/p 2	↘	↗	↗	↘
	No fault	Line fault	No fault	Line fault
LFD o/p 3	↘	↗	↘	↗
LFD o/p 4	↗	↘	↗	↘

Mode 6: 1 ch with start/stop latch

i/p Ch C	Non-latching ↗		
i/p Ch B	Enable ↘		
i/p Ch A	↗	↘	
o/p 1	↘	↗	
o/p 2	↗	↘	
o/p 3	↘	↗	
o/p 4	↗	↘	

- OR -

i/p Ch C	Latching ↗		
i/p Ch A	↗	Start ↗	Reset ↘
i/p Ch B	No effect	Stop ↘	
o/p 1	↘	↗	↘
o/p 2	↗	↘	↗
o/p 3	↘	↗	↘
o/p 4	↗	↘	↗

Mode 7: As mode 2 with LFD enabled

	i/p - Ch A			
	↗	↘	↗	↘
	No fault	Line fault	No fault	Line fault
o/p 1	↘	↗	↘	↗
o/p 3	↘	↗	↘	↗

	i/p - Ch C			
	↗	↘	↗	↘
o/p 2	↘	↗	↘	↗
o/p 4	↘	↗	↘	↗

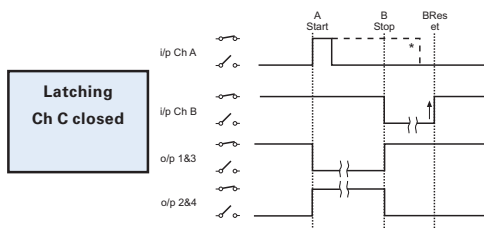
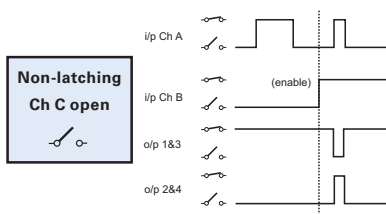

* i/p Ch A can be open or closed when i/p Ch B opens to stop latch

MTL5510B modes - continued

Mode 9: 2 ch with line fault output

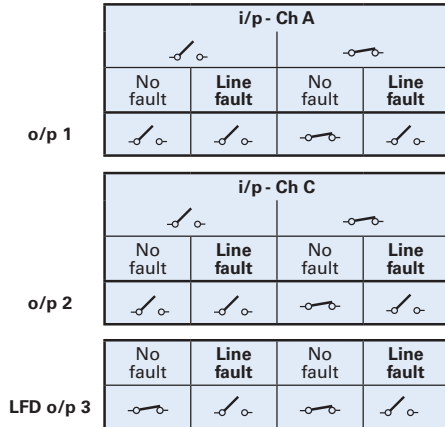

Mode 11: As mode 10 with ch phase reversed

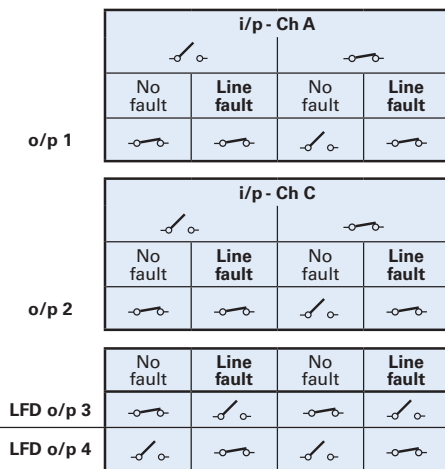

Mode 13: As mode 12 but with LFD o/p 4 reversed

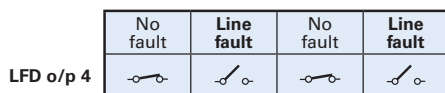

Mode 14

This mode provides a two channel pulse stretcher for inputs A and C. Outputs 1 and 2 respond to Ch A, while 3 and 4 respond to Ch C. Input B (or D) being open or closed affects the input

Mode 10: As mode 9 with line fault c/o

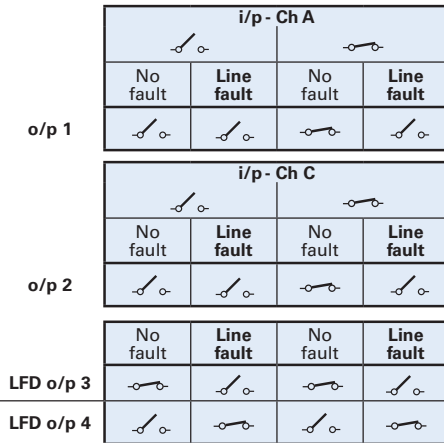

Mode 12: 3 ch with common LFD output

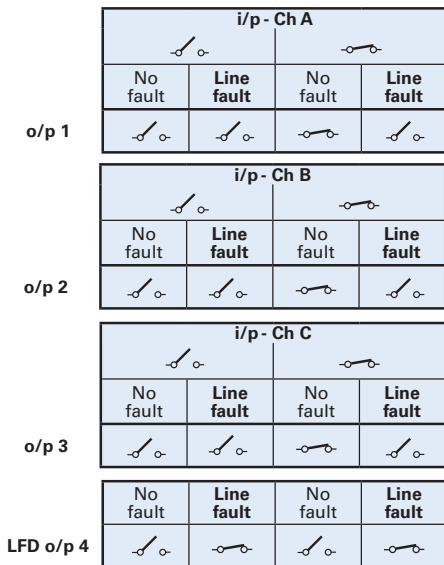

transition and the output polarity as shown in the timing diagrams below. When triggered by A (or C) the outputs hold the change of state for a minimum of 1 second or as long as the input (A or C) remains in the same triggered state.

Input Ch B (or D) closed

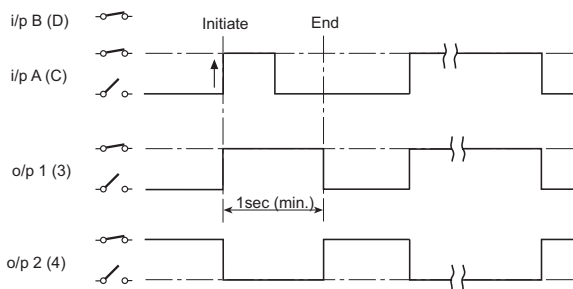

Input Ch B (or D) open

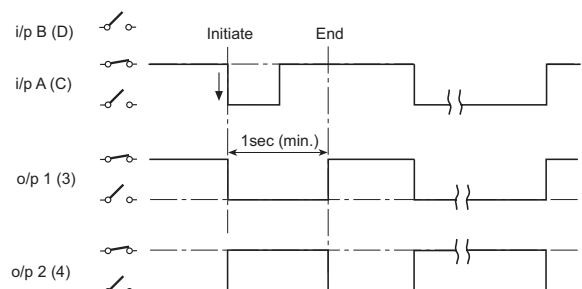

6.1.5 MTL5511 - Switch/Proximity detector interface

Single channel, with line-fault detection

The MTL5511 contains a changeover relay, which enables a safe-area load to be controlled by a switch or proximity detector located in a hazardous-area. When selected, the line-fault detect (LFD) facility detects open or short circuit conditions in the field wiring and also indicates this on the top of the module. **Line-Fault Detect** and **Phase Reversal** for the channel are selected by DIL switches on the side of the module and output is provided by the changeover relay contacts.

See page 19 for LFD and PR switch details. **Channel 1 only** switch settings apply.

For switch sensor inputs, with LFD selected, make sure resistors (22kΩ and 680Ω) are fitted.

Note: For reliable, long-term operation the load on the output switching relay should be not less than 50mW, e.g. 10mA at 5V DC.

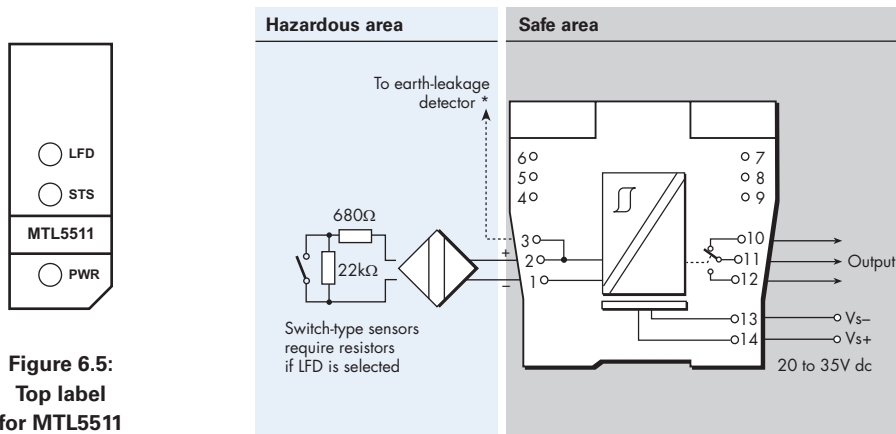

Terminal	Function
1	Input -ve
2	Input +ve
3	To earth leakage detector *
10	Output normally-closed contact
11	Output common
12	Output normally-open contact
13	Supply -ve
14	Supply +ve

* See Section 3.1.3 - modules require signal plug HAZ1-3 for access to this function.

6.1.6 MTL5513 - Switch/Proximity detector interface

Two-channel, with line-fault detection and phase reversal

The MTL5513 enables two solid-state outputs in the safe area to be controlled by two switches or proximity detectors located in the hazardous area. The Ch1/Ch2 output transistors share a common terminal and can switch +ve or -ve polarity signals. **Line-Fault Detect** and **Phase Reversal** for the channel are selected by DIL switches on the side of the module. LFD indication is provided on the top of the module.

See page 19 for LFD and PR switch details. **Channel 1 & 2** switch settings apply.

For switch sensor inputs, with LFD selected, make sure resistors (22kΩ and 680Ω) are fitted.

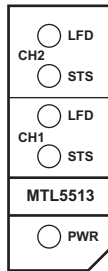
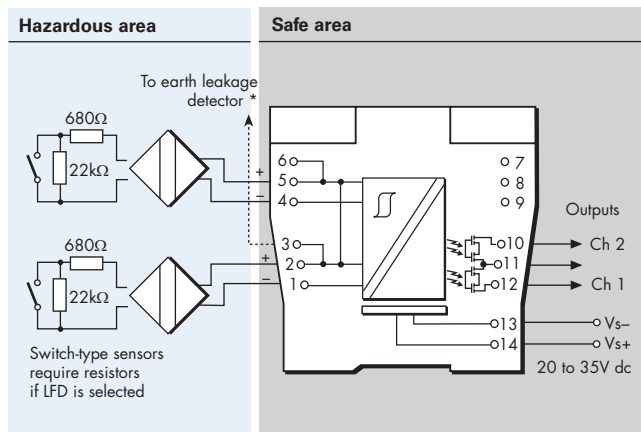

Figure 6.6:
Top label
for MTL5513



Terminal	Function
1	Input -ve (Ch 1)
2	Input +ve (Ch 1)
3	To earth leakage detector*
4	Input -ve (Ch 2)
5	Input +ve (Ch 2)
6	To earth leakage detector*
10	Output (Ch 2)
11	Output (Ch 1/Ch 2)
12	Output (Ch 1)
13	Supply -ve
14	Supply +ve

* See Section 3.1.3 - modules require signal plug HAZ1-3 for access to this function.

6.1.7 MTL5514/MTL5514D - Switch/Proximity detector interface

Single channel, with line-fault detection and phase reversal

The MTL5514 enables a safe-area load to be controlled, through a relay, by a proximity detector or switch located in a hazardous area. Line faults are signalled through a separate relay and indicated on the top of the module. The MTL5514D provides signal duplication, enabling two safe-area loads to be controlled by a single device in a hazardous area. Both relay outputs reflect the input signal instead of one showing the line fault condition as in the MTL5514. **Line-Fault Detect** and **Phase Reversal** for the channel are selected by DIL switches on the side of the module and output is provided by changeover relay contacts.

See page 19 for LFD and PR switch details. **Channel 1 only** switch settings apply.

For switch sensor inputs, with LFD selected, make sure resistors (22kΩ and 680Ω) are fitted.

Note: For reliable, long-term operation the load on the output switching relays should be not less than 50mW, e.g. 10mA at 5V DC.

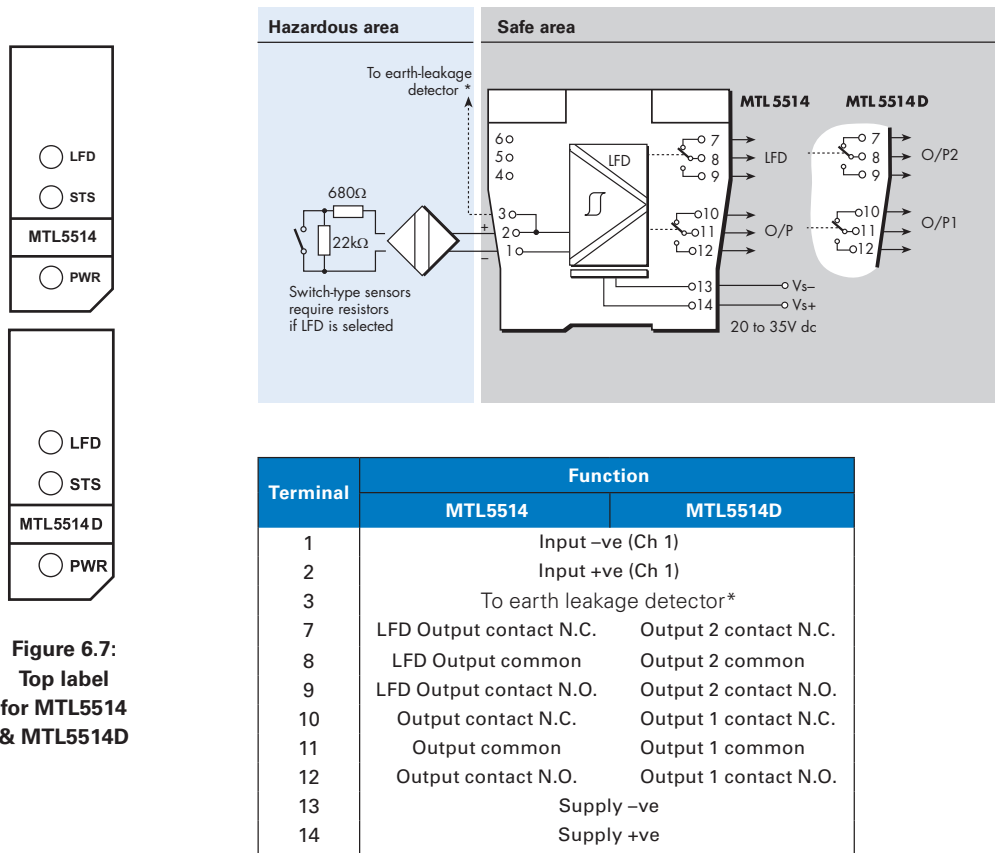

Figure 6.7:
Top label
for MTL5514
& MTL5514D

* See Section 3.1.3 - modules require signal plug HAZ1-3 for access to this function.

6.1.8 MTL5516C - Switch/Proximity detector interface

Two channel, with line-fault detection

The MTL5516C contains two changeover relays, which enable two safe-area loads to be controlled by switches or proximity detectors located in a hazardous-area. When selected, the line-fault detect (LFD) facility detects open or short circuit conditions in the field wiring and also indicates this on the top of the module. **Line-Fault Detect** and **Phase Reversal** for the channel are selected by DIL switches on the side of the module and output is provided by the changeover relay contacts.

See page 19 for LFD and PR switch details. **Channel 1 & 2** switch settings apply.

For switch sensor inputs, with LFD selected, make sure resistors (22kΩ and 680Ω) are fitted.

Note: For reliable, long-term operation the load on the output switching relays should be not less than 50mW, e.g. 10mA at 5V DC.

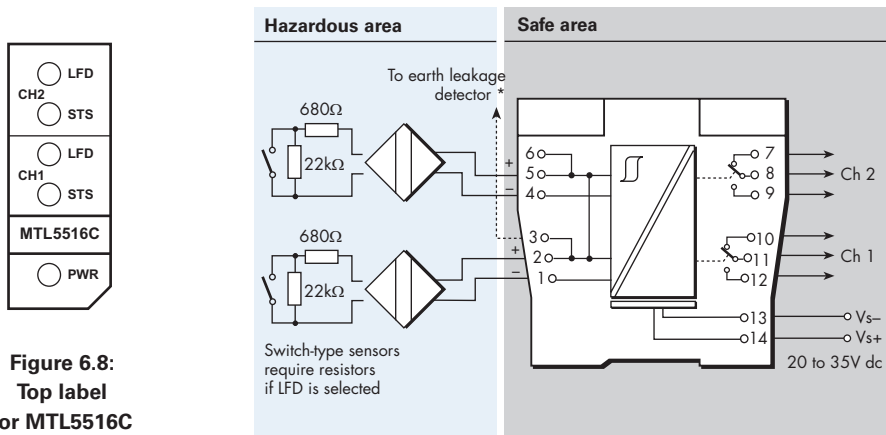

Figure 6.8:
Top label
for MTL5516C

Terminal	Function
1	Input -ve (Ch 1)
2	Input +ve (Ch 1)
3	To earth leakage detector*
4	Input -ve (Ch 2)
5	Input +ve (Ch 2)
6	To earth leakage detector*
7	Normally-closed contact (Ch 2)
8	Common (Ch 2)
9	Normally-open contact (Ch 2)
10	Normally-closed contact (Ch 1)
11	Common (Ch 1)
12	Normally-open contact (Ch 1)
13	Supply -ve
14	Supply +ve

* See Section 3.1.3 - modules require signal plug HAZ1-3 for access to this function.

6.1.9 MTL5517 - Switch/Proximity detector interface

Two channel, with line-fault detection and phase reversal

The MTL5517 enables two safe-area loads to be controlled, through a relay, by switches or proximity detectors located in a hazardous-area. When selected, the line-fault detect (LFD) is signalled through a separate relay and indicated on the top of the module. **Line-Fault Detect** and **Phase Reversal** for the channel are selected by DIL switches on the side of the module and output is provided by the relay contacts.

See page 19 for LFD and PR switch details. **Channel 1 & 2** switch settings apply.

For switch sensor inputs, with LFD selected, make sure resistors (22kΩ and 680Ω) are fitted.

Note: For reliable, long-term operation the load on the output switching relays should be not less than 50mW, e.g. 10mA at 5V DC.

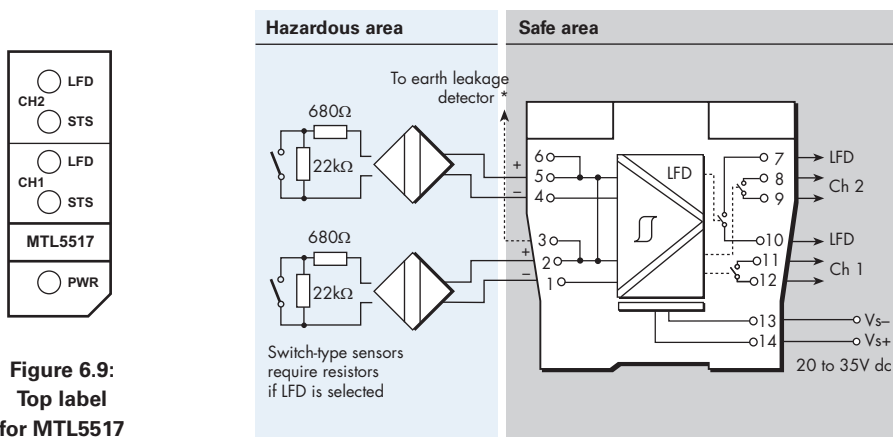

Figure 6.9:
Top label
for MTL5517

Terminal	Function
1	Input -ve (Ch 1)
2	Input +ve (Ch 1)
3	To earth leakage detector*
4	Input -ve (Ch 2)
5	Input +ve (Ch 2)
6	To earth leakage detector*
7	Line-fault detection
8	Output (Ch 2)
9	Output (Ch 2)
10	Line-fault detection
11	Output (Ch 1)
12	Output (Ch 1)
13	Supply -ve
14	Supply +ve

* See Section 3.1.3 - modules require signal plug HAZ1-3 for access to this function.

6.2 Digital Output modules

The single channel Digital Output (DO) module range enables on/off devices in a hazardous area to be controlled from the safe area. Some units are loop powered while others enable solid-state switching by providing independent power supplies.

6.2.1 MTL5521 - Solenoid Alarm driver

Single channel, loop powered, IIC

The MTL5521 is a loop-powered module that enables a device located in the hazardous area (IIC gas group) to be controlled from the safe area. The MTL5521 can drive a certified intrinsically safe low-power load, as well as non-energy-storing simple apparatus such as an LED.



Figure 6.10:
Top label
for MTL5521

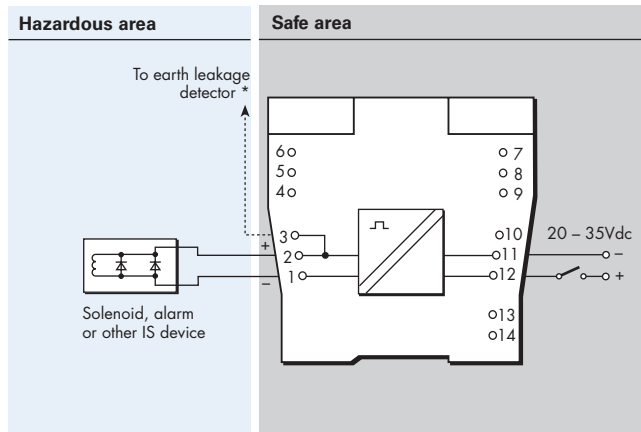

Terminal	Function
1	Output -ve
2	Output +ve
3	To earth leakage detector*
11	Supply -ve
12	Supply +ve

* See Section 3.1.3 - modules require signal plug HAZ1-3 for access to this function.

6.2.2 MTL5522 - Solenoid Alarm driver

Single channel, loop powered, IIB

The MTL5522 is a loop-powered module which enables a device located in the hazardous area (IIB gas group) to be controlled from the safe area. The MTL5522 can drive a certified intrinsically safe, low-power load as well as non-energy-storing simple apparatus such as an LED.

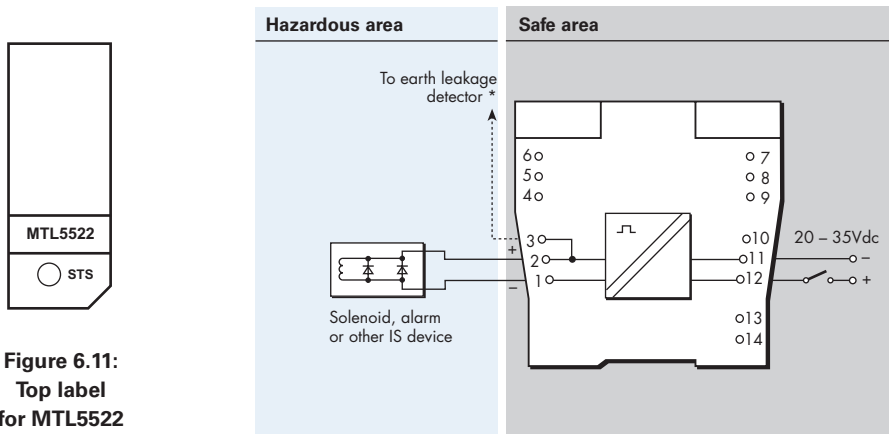

Figure 6.11:
Top label
for MTL5522

Terminal	Function
1	Output -ve
2	Output +ve
3	To earth leakage detector*
11	Supply -ve
12	Supply +ve

* See Section 3.1.3 - modules require signal plug HAZ1-3 for access to this function.

6.2.3 MTL5523 - Solenoid Alarm driver

Single channel, with line-fault detection, IIC

The MTL5523 interface controls an on/off device in a hazardous area using a volt-free contact or logic signal in the safe area, and is suitable for driving loads such as solenoids. Line-Fault Detection (LFD) operates independently of the output state and is signalled by a safe-area, solid-state switch output which, when a field line is open or short-circuited, becomes de-energised. Earth-fault detection can be provided by connecting an MTL4220 earth leakage detector to terminal 3. Earth-fault detection can be provided by connecting an MTL4220 earth leakage detector to terminal 3.

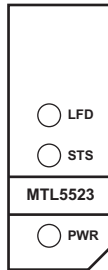
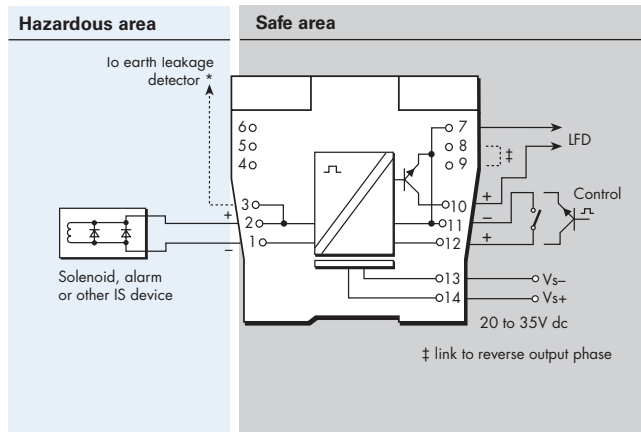

Figure 6.12:
Top label
for MTL5523



Terminal	Function
1	Output -ve
2	Output +ve
3	To earth leakage detector*
7	Line fault signal -ve
8	Phase reversal link
9	Phase reversal link
10	Line fault signal +ve
11	Control -ve
12	Control +ve
13	Supply -ve
14	Supply +ve

* See Section 3.1.3 - modules require signal plug HAZ1-3 for access to this function.

6.2.4 MTL5523V/MTL5523VL - Solenoid Alarm driver

Single channel, voltage controlled with line-fault detection, IIC

With the MTL5523V or MTL5523VL interface, an on/off device in a hazardous area can be controlled by a voltage signal in the safe area. It is suitable for driving loads such as solenoids. Line fault detection (LFD), which operates irrespective of the output state, is signalled by a safe-area, solid-state switch which energises if a field line is open or short-circuited.

The VL version has a lower current capability to suit alternative load requirements- see datasheet.

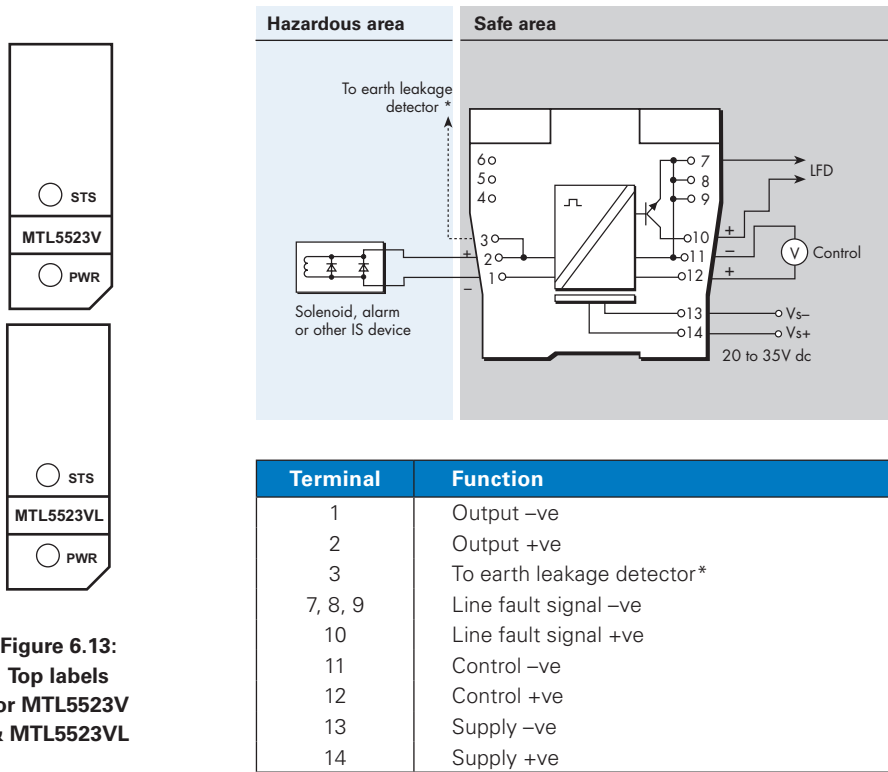

Figure 6.13:
Top labels
for MTL5523V
& MTL5523VL

*See Section 3.1.3 - modules require signal plug HAZ1-3 for access to this function

6.2.5 MTL5524 - Solenoid Alarm driver

Single channel, powered, logic drive with phase reversal

The MTL5524 enables an on/off device in a hazardous area to be controlled by a volt-free contact or logic signal in the safe area. It can drive loads such as solenoids, alarms, LEDs and other low power devices that are certified as intrinsically safe or are classified as non-energy-storing simple apparatus.

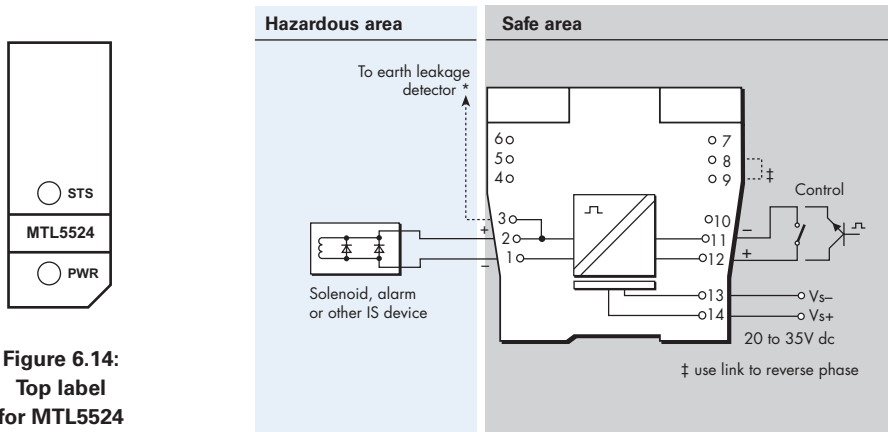

Figure 6.14:
Top label
for MTL5524

Terminal	Function
1	Output -ve
2	Output +ve
3	To earth leakage detector*
8	Phase reversal link
9	Phase reversal link
11	Control -ve
12	Control +ve
13	Supply -ve
14	Supply +ve

* See Section 3.1.3 - modules require signal plug HAZ1-3 for access to this function.

6.2.6 MTL5525 - Solenoid Alarm driver

Single channel, low current, loop powered, IIC

The MTL5525 enables an on/off device in a hazardous area (IIC gas group) to be controlled by a switch or voltage change in the safe area. It can drive loads such as solenoids, alarms, LEDs and other low power devices that are certified as intrinsically safe or are classified as non-energy-storing simple apparatus. Similar in function to the MTL5521, this module provides lower power output and corresponding reduced safety description.

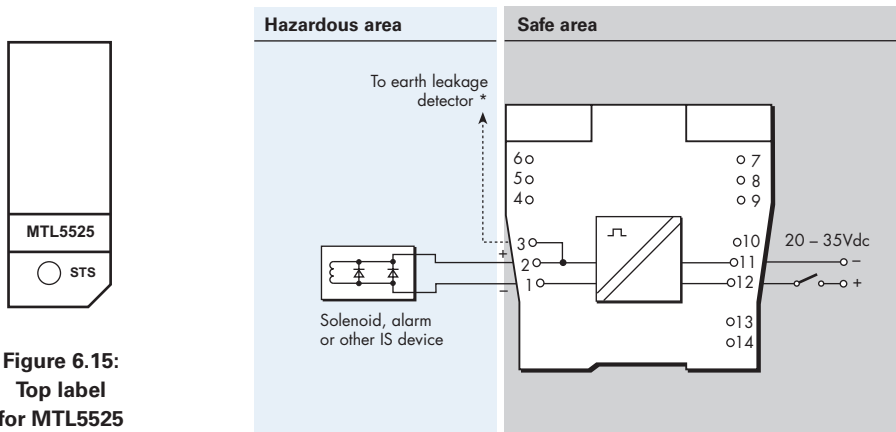

Figure 6.15:
Top label
for MTL5525

Terminal	Function
1	Output -ve
2	Output +ve
3	To earth leakage detector*
11	Supply -ve
12	Supply +ve

* See Section 3.1.3 - modules require signal plug HAZ1-3 for access to this function.

6.2.7 MTL5526- Switch Operated Relay

Two channel, output

The MTL5526 enables two separate IS circuits in a hazardous area to be relay-contact controlled by two on-off switches or logic signals in a safe area. Applications include the calibration of strain-gauge bridges; changing the polarity (and thereby the tone) of an IS sounder; the testing of IS fire alarms; and the transfer of safe-area signals into an annunciator with IS input terminals not segregated from each other.

The output-relay contacts are certified as non-energy-storing apparatus, and can be connected to any IS circuit without further certification, provided that separate IS circuits are such that they would remain safe if connected together.

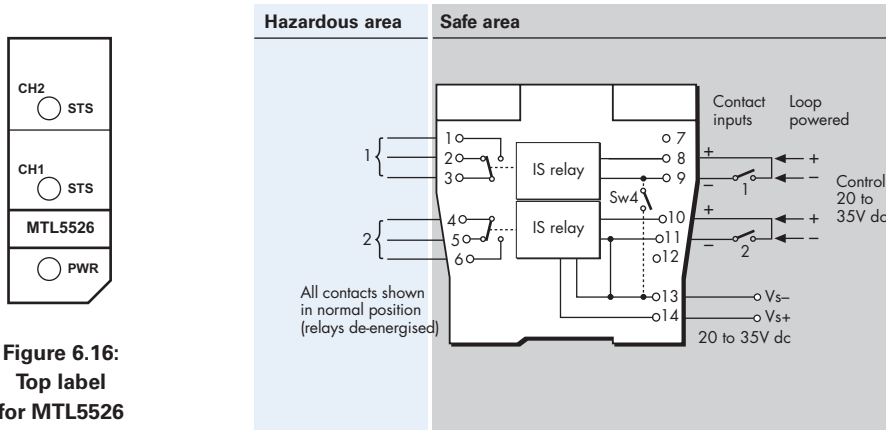
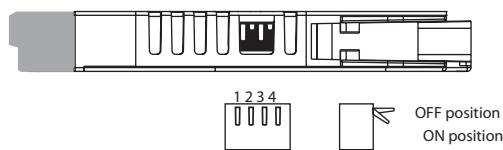

Figure 6.16:
Top label
for MTL5526

Terminal	Function
1	IS relay output 1 (normally open)
2	IS relay output 1 (normally closed)
3	IS relay output 1 (common)
4	IS relay output 2 (common)
5	IS relay output 2 (normally closed)
6	IS relay output 2 (normally open)
8	Relay 1 control +ve
9	Relay 1 control -ve
10	Relay 2 control +ve
11	Relay 2 control -ve
13	Supply -ve
14	Supply +ve

Table 6.3:
Switch settings
for modes

Mode	Function	SW1	SW2	SW3	SW4
Contact/Logic Input	2 ch	Off	On	On	On
	1in2out	On	On	On	On
Loop Powered	2 ch	Off	Off	Off	Off



6.3 Pulse and Vibration modules

Single and dual channel modules are available to transfer vibration probe signals from a hazardous area to a safe one. Similarly, pulses from a switch, proximity detector, current pulse transmitter or voltage pulse transmitter, located in the hazardous area, can be safely transferred to the safe area.

6.3.1 MTL5531 - Vibration Transducer Interface

Single channel

The MTL5531 repeats a signal from a vibration sensor in a hazardous area, providing an output for a monitoring system in the safe area. The interface is compatible with 3-wire, eddy-current probes and accelerometers or 2-wire current sensors, and selection of the mode is made with a switch located on the side of the module.

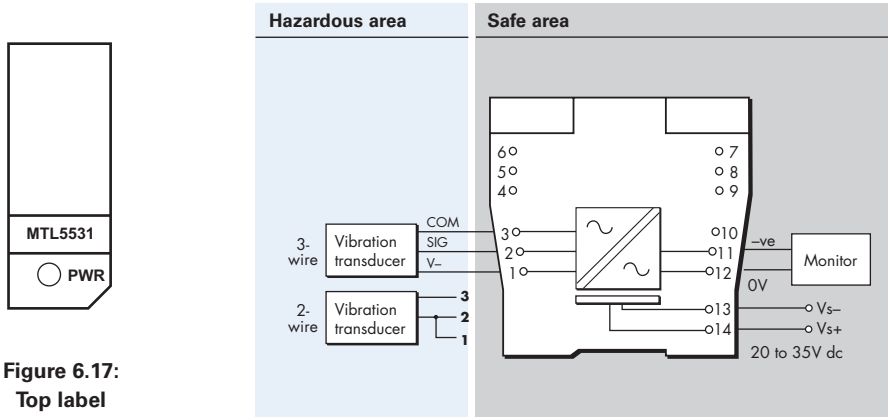
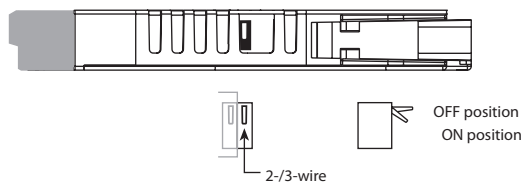

Figure 6.17:
Top label
for MTL5531

Terminal	Function
1	Transducer power V-
2	Signal
3	Common
11	Signal output -ve
12	Signal output 0V
13	Supply -ve
14	Supply +ve

2-/3-wire transducer setting switch



Mode	SW
2-wire (3.3mA)*	OFF
3-wire (20mA)	ON

* **Note:** When using 2-wire sensors, ensure that terminals 1 and 2 are linked as shown in the wiring diagram above.



WARNING

WARNING

To enable optimum heat dissipation the recommended orientation for mounting is with the module vertical, i.e. with the vents in the case at the top and bottom. This enables air to flow through the module.

In any other orientation, i.e. with the module horizontal, then the maximum ambient temperature is limited to:

- Close packed = 45°C
- Minimum of 10mm spacing = 55°C

Eaton produce the MS010 DIN rail module spacer for this purpose (packs of 5 - see Section 4.3)

6.3.2 MTL5532 - Pulse Isolator

Pulse & 4/20mA current outputs

The MTL5532 isolates pulses from a switch, proximity detector, current pulse transmitter or voltage pulse transmitter located in a hazardous area. It is ideal for applications involving high pulse rates and fast response times, by repeating the pulses into the safe area, and the transistors used on the pulse output will switch +ve or -ve polarity signals.

It may be used immediately in simple or legacy mode, or it may be software configured for more specific applications- see next page for either option. With configuration, an analogue output proportional to frequency is available, together with a relay output, which may act as an alarm.

Note: For reliable, long-term operation the load on the output switching relay should not be less than 50mW, e.g.10mA at 5VDC.

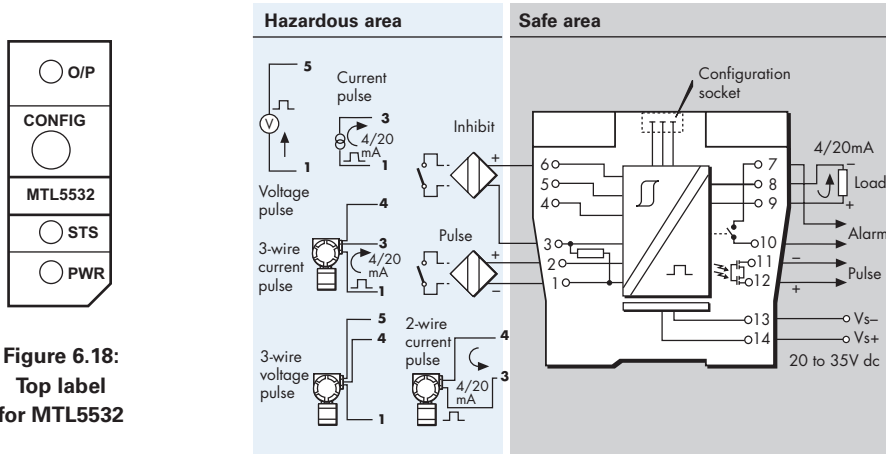

Figure 6.18:
Top label
for MTL5532

Terminal	Function
1	Common input -ve
2	Switch/proximity input +ve
3	Current pulse input +ve
4	Transmitter supply +ve
5	Voltage pulse input +ve
6	Inhibit input +ve
7	Alarm output
8	Current output -ve
9	Current output +ve
10	Alarm output
11	Pulse output -ve
12	Pulse output +ve
13	Supply -ve
14	Supply +ve

Switches located on the edge of the module define the mode of operation.



SW1	SW2	SW3	SW4
Vsp	Vsp	LFD	Mode

Vsp	SW1	SW2
3V	ON	ON
6V	ON	OFF
12V	OFF	OFF

LFD	SW3
OFF	OFF
ON	ON

Switch input operation

If switch contacts are used for this Pulse Input (terminals 1 & 2), then and parallel resistors must be fitted- see Section 6.1.2 for recommended values.

Simple or Legacy mode - SW4 - OFF

If simple "pulse-in/pulse-out" operation is required or, if a replacement for the earlier MTL5032 pulse isolator is required, then SW4 should be set to OFF. The input switching point voltage (Vsp) thresholds can then be defined by Switches 1 & 2, and the LFD operation can be set with Switch 3. When Switch 3 is ON, the Alarm output (terminals 11 & 12) become active.

Configurable mode - SW4 - ON

In this mode, analogue, alarm and pulse outputs are available but the module *must* be software configured to define its operating mode. In this mode, software controls the LFD function and Switch 3 has no effect. Switches 1 & 2 continue to define the switching point threshold (Vsp). Configuration requires a personal computer, a PCL45USB interface and PCS45 software. See Section 6.9 for details of the configurator.

Alarm inhibiting

The Inhibit input is provided to inhibit alarm output operation. This facility is useful, for example, during power-up, when pulse rates are below the alarm threshold. When normal operational values are established the inhibit can be disabled. Such a facility is sometimes referred to as a start-up delay. Inhibit is enabled by connecting a switch or proximity detector between terminals 6 and 3. If switch contacts are used for this input, then and parallel resistors must be fitted- see Section 6.1.2 for recommended values.

LED indicators

Use the following LED information to understand the module status.

LED	Description
PWR Power (green)	ON - Power OK OFF - No power or insufficient voltage
O/P Output (yellow)	The LED will follow the pulse output state. If the output is pulsing then the LED brightness will pulse. If the pulsing is rapid or very short, the LED may dim if it is unable to respond to such changes. If the output is high, the LED will be ON.
STS Status (red - flashing)	In legacy mode a line fault will cause the LED to turn ON. In mC mode, the LED is programmable to display a line fault or an Alarm trip operation. In the event, it will also indicate a mC fault condition.

6.3.3 MTL5533 - Vibration Transducer Interface

Two channel

The MTL5533 repeats signals from vibration sensors in a hazardous area, providing outputs for monitoring systems in the safe area. The interface is compatible with 3-wire eddy-current probes and accelerometers or 2-wire current sensors, and selection of the mode for each channel is made with the switches on the side of the module.

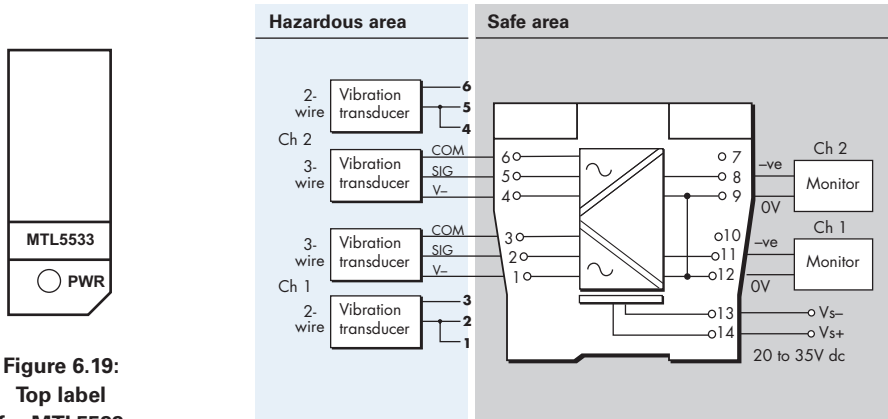
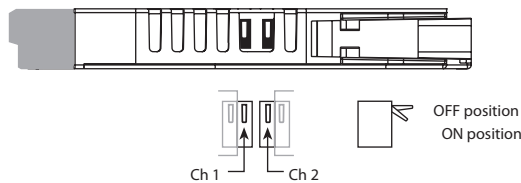

Figure 6.19:
Top label
for MTL5533

Terminal	Function
1	Transducer power V- (Ch1)
2	Signal (Ch1)
3	Common (Ch1)
4	Transducer power V- (Ch2)
5	Signal (Ch2)
6	Common (Ch2)
8	Signal output -ve (Ch2)
9	Signal output 0V (Ch2)
11	Signal output -ve (Ch1)
12	Signal output 0V (Ch1)
13	Supply -ve
14	Supply +ve

2-/3-wire transducer setting switches



Mode	SW
2-wire (3.3mA)	OFF
3-wire (20mA)	ON

* **Note:** When using 2-wire sensors, ensure that terminals 1 & 2 and 4 & 5 have wiring links as shown in the wiring diagram above.

 WARNING!	<p>WARNING!</p> <p>To enable adequate heat dissipation from the MTL5533 modules, they must be installed on the DIN rail with a 10mm space between adjacent units. Eaton produce the MS010 DIN rail module spacer for this purpose (packs of 5 - see Section 4.3), and these then enable operation in ambient temperatures of up to 50°C in vertical or horizontal orientation.</p>
---------------------	-------------------------------------------------------------------------------------------------------------------------------------------------------------------------------------------------------------------------------------------------------------------------------------------------------------------------------------------------------------------------------------------

6.4 Analogue Input modules

The analogue input (AI) modules support 2-wire or 3-wire 4/20mA or HART transmitters located in a hazardous area; repeating the current in other circuits to drive safe-area loads.

6.4.1 MTL5541/MTL5541S- Repeater Power Supply

Single channel, for 4/20mA HART® for 2- or 3-wire transmitters

The MTL5541 provides a fully-floating dc supply for energising a conventional 2- or 3-wire 4/20mA transmitter which is located in a hazardous area, and repeats the current in another floating circuit to drive a safe-area load. For HART 2-wire transmitters, the unit allows bi-directional communications signals superimposed on the 4/20mA loop current. Alternatively, the MTL5541S acts as a current sink for a safe-area connection rather than driving a current into the load. Separately powered current sources, such as 4-wire transmitters, can be connected but will not support HART communication.

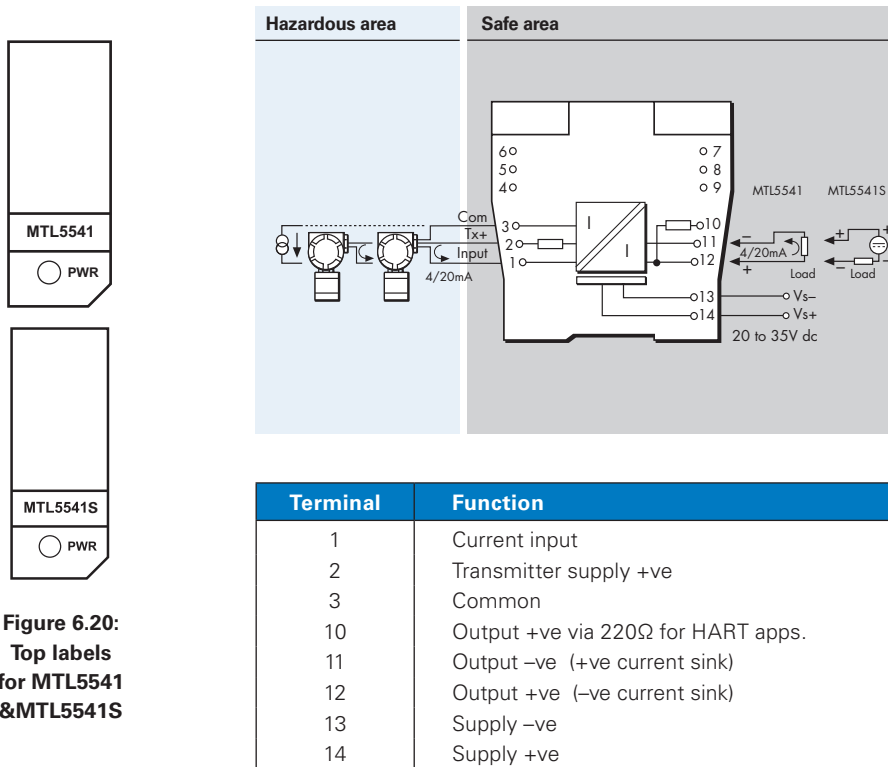

Figure 6.20:
Top labels
for MTL5541
&MTL5541S

6.4.2 MTL5541A/MTL5541AS - Repeater Power Supply

Single channel, for 4/20mA, HART® for 2- or 3-wire transmitters

The MTL5541A provides an input for separately powered 4/20mA transmitters and also allows bi-directional transmission of HART communication signals superimposed on the 4/20mA loop current. Alternatively, the MTL5541AS acts as a current sink for a safe-area connection rather than driving a current into the load.

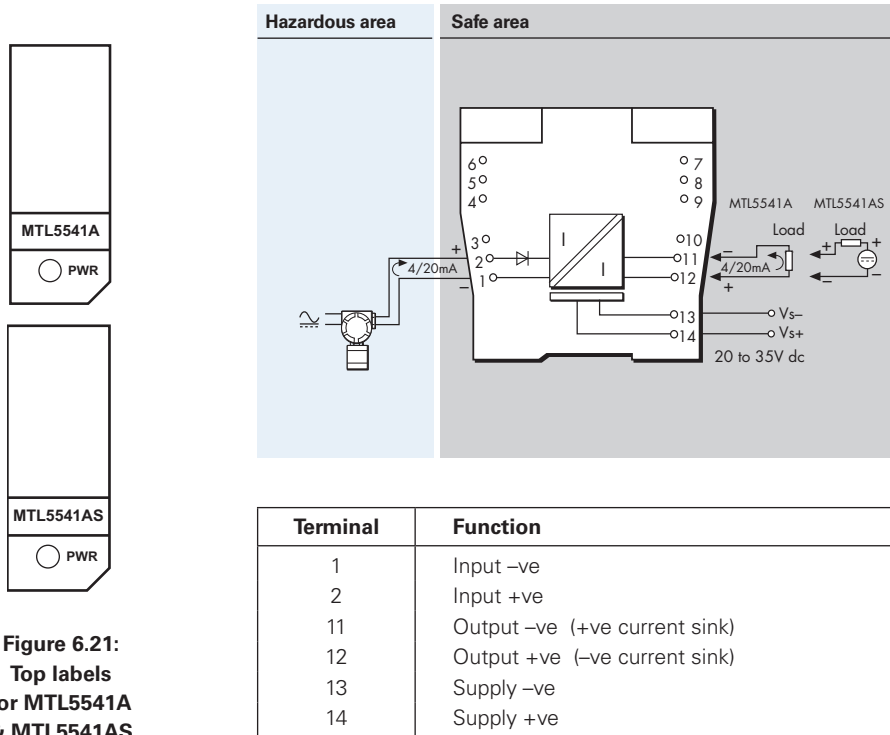

Figure 6.21:
Top labels
for MTL5541A
& MTL5541AS

6.4.3 MTL5544/MTL5544S - Repeater Power Supply

Two channel, for 4/20mA HART® for 2- or 3-wire transmitters

The MTL5544 provides fully-floating dc supplies for energising two conventional 2-wire or 3-wire 4/20mA or HART transmitters located in a hazardous area, and repeats the current in other circuits to drive two safe-area loads. For HART transmitters, the unit allows bi-directional transmission of digital communication signals superimposed on the 4/20mA loop current. Alternatively, the MTL5544S acts as a current sink for a safe-area connection rather than driving a current into the load. Separately powered current sources, such as 4-wire transmitters, can be connected but will not support HART communication.

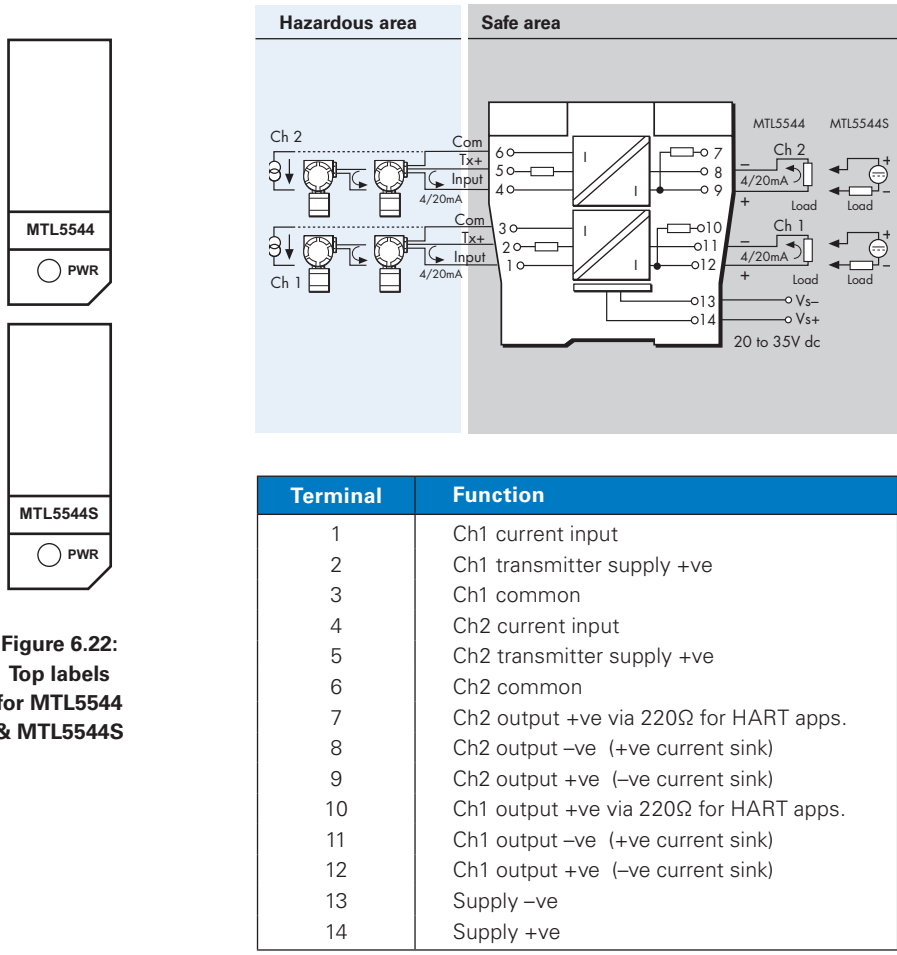
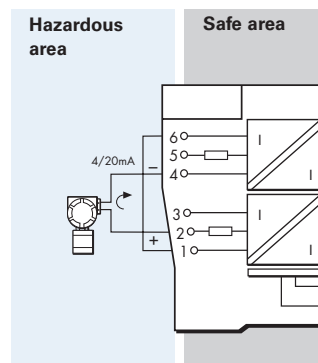

Figure 6.22:
Top labels
for MTL5544
& MTL5544S

The MTL5544 or MTL5544S can also be used to drive two safe-area loads from a single 2-wire transmitter (i.e. 1 in, 2 out) by interconnecting the input channels as shown in the diagram (right).

Note: In this mode the HART data is transferred via channel 1 output only.

See also the MTL5544D.



6.4.4 MTL5544A/MTL5544AS - Current Repeater

Two channel, for 4/20mA passive input for HART® transmitters

The MTL5544A provides an input for separately powered 4/20mA transmitters and also allows bi-directional transmission of HART communication signals superimposed on the 4/20mA loop current. Alternatively, the MTL5544AS acts as a current sink for a safe-area connection rather than driving a current into the load.

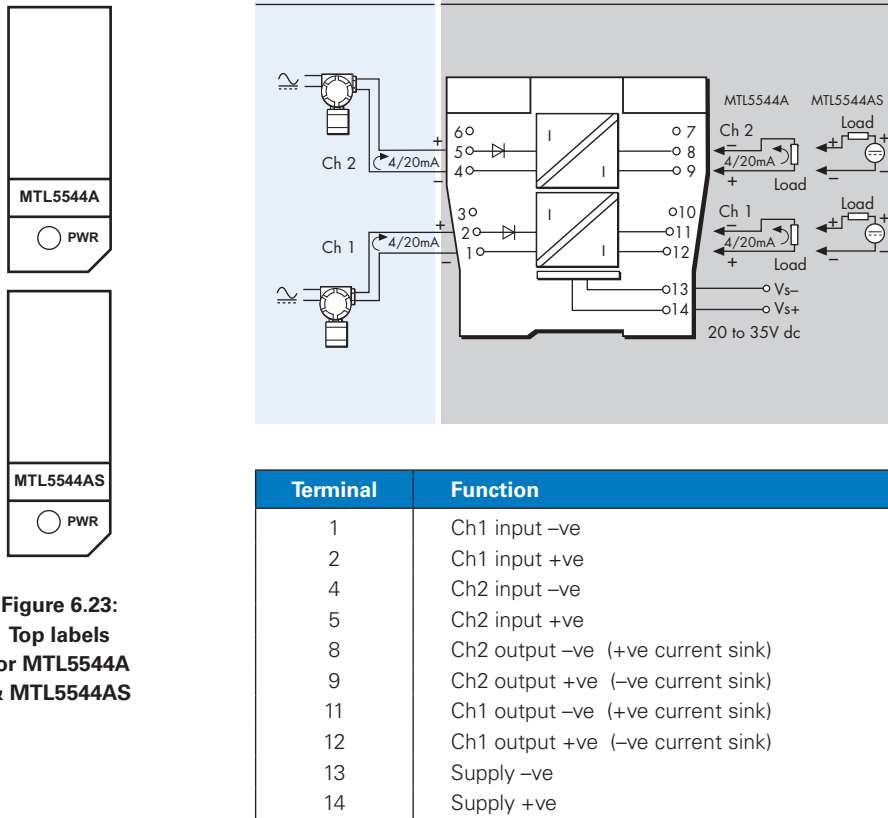

Figure 6.23:
Top labels
for MTL5544A
& MTL5544AS

6.4.5 MTL5544D - Repeater Power Supply

Two channel, for 4/20mA HART® for 2- or 3-wire transmitters, two outputs

The MTL5544D provides a fully-floating dc supply for energising a conventional 2- or 3-wire 4/20mA transmitter located in a hazardous area, and repeats the current in other circuits to drive two safe-area loads. For HART 2-wire transmitters, the unit allows bi-directional transmission of digital communication signals superimposed on the 4/20mA loop current. Separately powered current sources, such as 4-wire transmitters, can be connected but will not support HART communication.

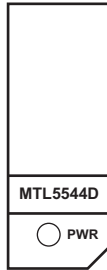
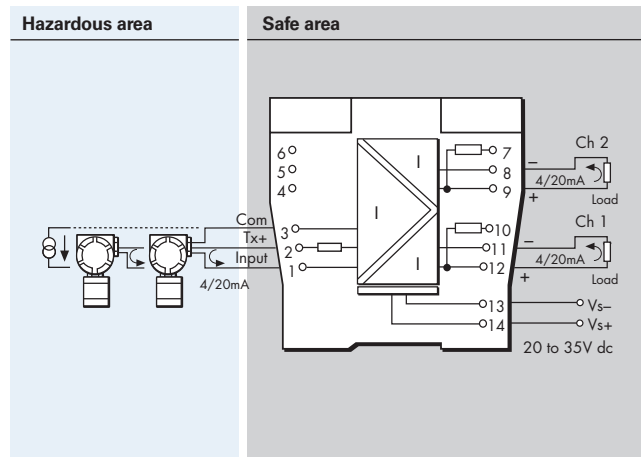

Figure 6.24:
Top label
for MTL5544D



Terminal	Function
1	Current input
2	Transmitter supply +ve
3	Common
7	Ch2 output +ve via 220Ω for HART apps.
8	Ch2 output -ve
9	Ch2 output +ve
10	Ch1 output +ve via 220Ω for HART apps.
11	Ch1 output -ve
12	Ch1 output +ve
13	Supply -ve
14	Supply +ve

NOTE: For correct operation of the module, a suitable load must be present on *both* output channels. This is of particular importance during testing, commissioning or maintenance activities when the temporary disconnection, or absence, of a load can affect the transfer accuracy of the analogue variable.

6.5 Analogue Output modules

The analogue output (AO) modules accept 4/20mA floating signals from safe-area controllers to drive current/pressure converters (or any other load up to 800Ω) in a hazardous area.

6.5.1 MTL5546/MTL5546Y - Isolating Driver

Single channel, for 4/20mA HART® valve positioners with line-fault detection

The MTL5546 accepts a 4/20mA floating signal from a safe-area controller to drive a current/pressure converter (or any other load up to 800Ω) in a hazardous area. For HART valve positioners, the module also permits bi-directional transmission of digital communication signals so that the device can be interrogated either from the operator station or by a hand-held communicator. Process controllers with a readback facility can detect open or short circuits in the field wiring: if these occur, the current taken into the terminals drops to a preset level. The MTL5546Y is very similar to the MTL5546 except that it provides open circuit detection *only* (i.e. no short-circuit detection).

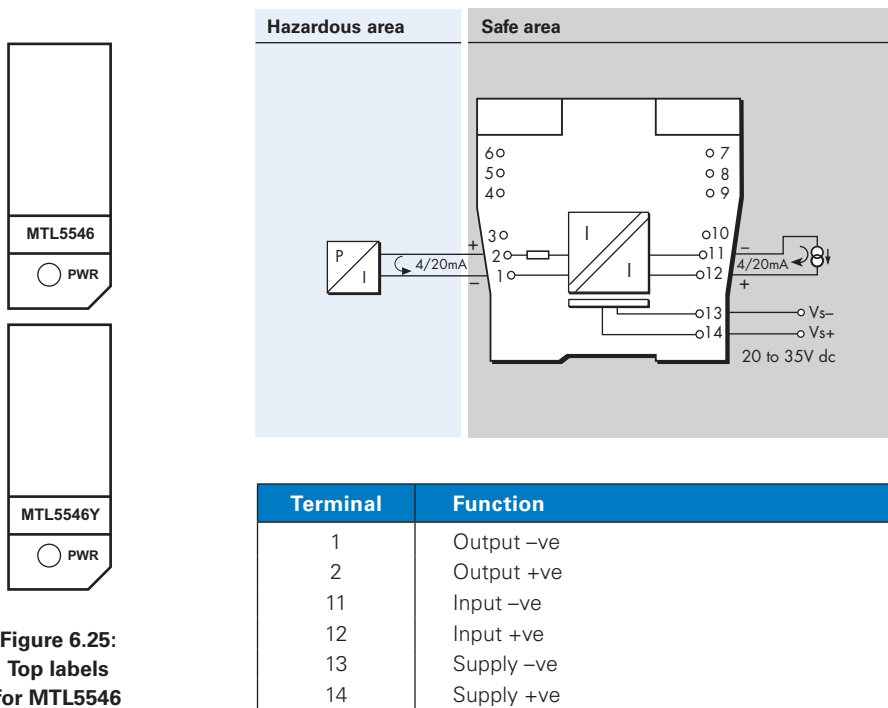

Figure 6.25:
Top labels
for MTL5546
& MTL5546Y

Input characteristics

Field wiring state	MTL5546	MTL5546Y
Normal	<6.0V	<6.0V
Open-circuit	<0.9mA	<0.5mA
Short-circuit	<0.9mA	N.A.

6.5.2 MTL5549/ MTL5549Y - Isolating Driver

Two channel, for 4/20mA HART® valve positioners with line-fault detection

The MTL5549 accepts 4/20mA floating signals from safe-area controllers to drive 2 current/pressure converters (or any other load up to 800Ω) in a hazardous area. For HART valve positioners, the module also permits bi-directional transmission of digital communication signals so that the device can be interrogated either from the operator station or by a hand-held communicator. Process controllers with a readback facility can detect open or short circuits in the field wiring: if these occur, the current taken into the terminals drops to a preset level. The MTL5549Y is very similar to the MTL5549 except that it provides open circuit detection *only* (i.e. no short-circuit detection).

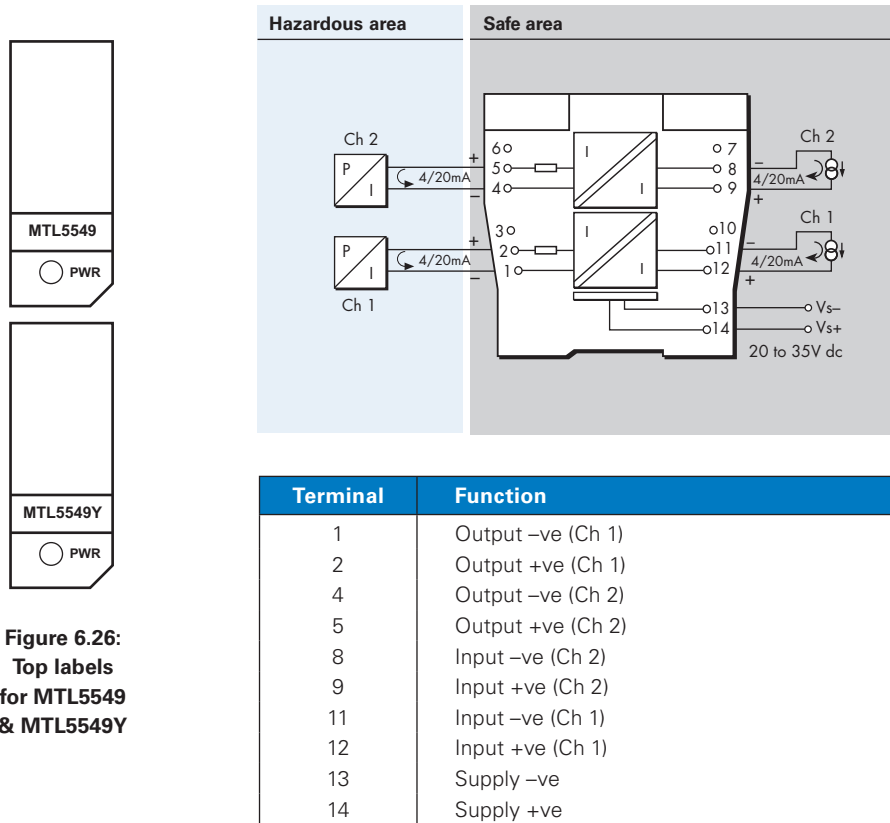

Figure 6.26:
Top labels
for MTL5549
& MTL5549Y

Input characteristics

Field wiring state	MTL5549	MTL5549Y
Normal	<6.0V	<6.0V
Open-circuit	<0.9mA	<0.5mA
Short-circuit	<0.9mA	N.A.

6.6 Fire and Smoke Interface modules

Interfaces for use with conventional fire and smoke detectors located in hazardous areas.

6.6.1 MTL5561 - Fire and Smoke Detector Interface

Two channel

The MTL5561 is a loop-powered 2-channel interface for use with conventional fire and smoke detectors located in hazardous areas. In operation, the triggering of a detector causes a corresponding change in the safe-area current. The unit features reverse input polarity protection, while 'no-fail' earth fault detection on either line can be provided by connecting an earth leakage detector to terminal 3 and/or 6.

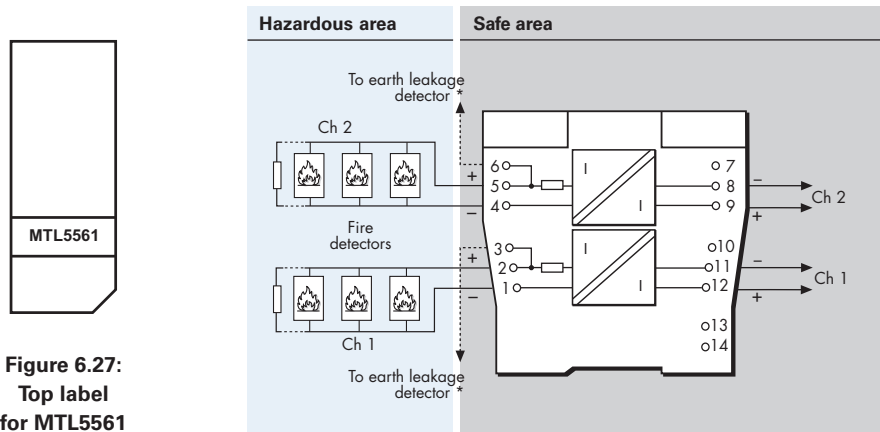

Figure 6.27:
Top label
for MTL5561

Terminal	Function
1	Output -ve (Ch 1)
2	Output +ve (Ch 1)
3	Earth leakage detection (Ch 1)
4	Output -ve (Ch 2)
5	Output +ve (Ch 2)
6	Earth leakage detection (Ch 2)
8	Input -ve (Ch 2)
9	Input +ve (Ch 2)
11	Input -ve (Ch 1)
12	Input +ve (Ch 1)

6.7 Temperature Input module

These modules accept inputs from low-level dc sources such as thermocouples or RTDs in hazardous areas and converts them into 4/20mA signals to drive safe area loads.

Thermocouples Early burnout detection (EBD)

When EBD is selected, the resistance of the thermocouple circuit is monitored and an alarm is raised when there is an increase of more than 50W. This enables preventative maintenance to be conducted on the field installation before the thermocouple actually breaks.

Configuration using PCS45/PCL45USB

Use PCS45 software, in conjunction with the PCL45USB serial link, to configure these modules. Instructions are contained within the software. See Section 6.9 on page 58 for further details.

All MTL5573 and MTL5575 modules are supplied with the following default configuration.

Input type	Type K thermocouple
Linearisation	enabled
Units	°C
CJ Compensation	enabled
Damping value	0 seconds
Smoothing value	0 seconds
Output zero	0°C
Output span	250°C
Tag and description fields	blank
Open circuit alarm	set high (upscale)
Transmitter failure alarm	set low (downscale)
CJ failure alarm	set low (downscale)
Line frequency	50Hz

Use PCS45 software, in conjunction with the PCL45USB serial link, to modify these default values.

6.7.1 MTL5573 - Temperature Converter

Single channel, THC or RTD input

The MTL5573 converts a low-level dc signal from a temperature sensor mounted in a hazardous area into a 4/20mA current for driving a safe-area load. Software selectable features include linearisation, ranging, monitoring, testing and tagging for all thermocouple types and 2-, 3- or 4-wire RTDs. (For thermocouple applications the HAZ-CJC plug on terminals 1–3 includes an integral CJC sensor). Configuration is carried out using a personal computer.

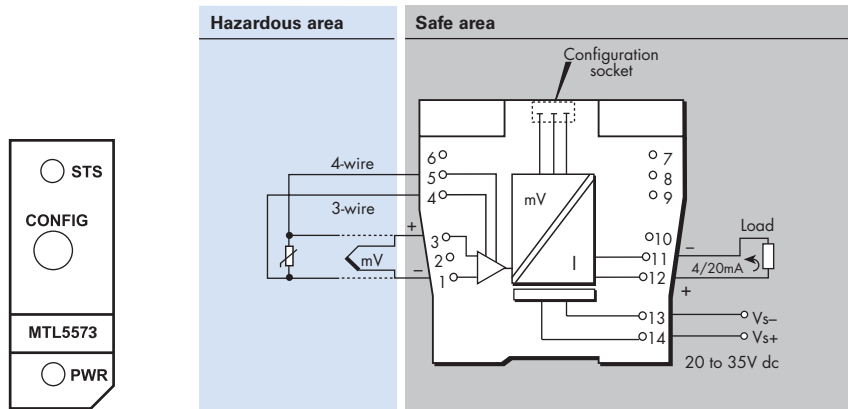

Figure 6.32:
Top labels for
MTL5573

Terminal	Function
1	THC/EMF/RTD input -ve
3	THC/EMF/RTD input +ve
4	3-wire RTD input -ve
5	4-wire RTD input +ve
11	Output -ve
12	Output +ve
13	Supply -ve
14	Supply +ve

Top label

Use the following LED information to understand the module status.

Status	PWR (green)	STS (yellow)
Power ON	ON	
Insufficient voltage or Power OFF	OFF	
Normal working	ON	
Device failure	FLASH	
Sensor failure/Error	FLASH	
Early burnout detection (EBD)	FAST FLASH	

6.7.2 MTL5575 - Temperature Converter

Single channel, THC or RTD input with alarm

The MTL5575 converts a low-level dc signal from a temperature sensor mounted in a hazardous area into a 4/20mA current for driving a safe-area load. Software selectable features include linearisation, ranging, monitoring, testing and tagging for all thermocouple types and 2, 3 or

4-wire RTDs. (For thermocouple applications the HAZ-CJC plug, on terminals 1–3, includes an integral CJC sensor). Configuration is carried out using a personal computer- see section 6.9. A single alarm output is provided and may be configured for process alarm or to provide notice of early thermocouple failure.

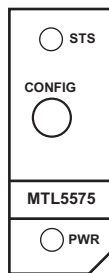
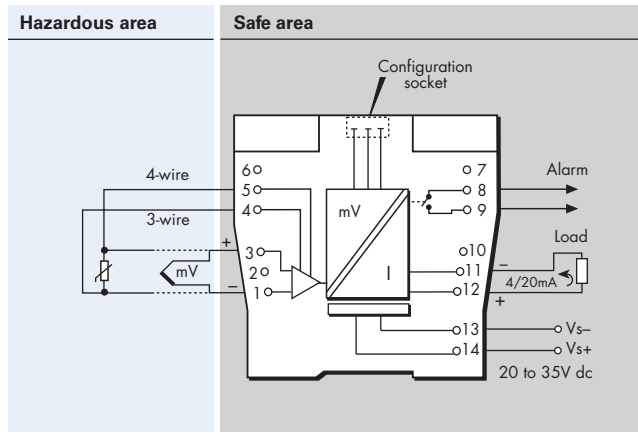

Figure 6.28:
Top label
for MTL5575



Terminal	Function
1	THC/EMF/RTD input -ve
3	THC/EMF/RTD input +ve
4	3-wire RTD input -ve
5	4-wire RTD input +ve
8	Alarm relay
9	Alarm relay
11	Output -ve
12	Output +ve
13	Supply -ve
14	Supply +ve

Top label

Use the following LED information to understand the module status.

Status	PWR (green)	STS (yellow)
Power ON	ON	
Insufficient voltage or Power OFF	OFF	
Normal working	ON	
Device failure	FLASH	
Sensor failure/Error	FLASH	
Output relay ON (Trip)	ON	ON
Output relay OFF (Trip)	ON	OFF
Early burnout detection (EBD)	FAST FLASH	

6.7.3 MTL5576-RTD - Temperature Converter

Two channel, RTD/potentiometer input

The MTL5576-RTD converts signals from resistance temperature detectors (RTDs) mounted in a hazardous area, into 4/20mA currents for driving safe-area loads. The MTL5576-RTD is compatible with 2- and 3-wire RTD inputs.

Performance features, including input type and characterisation, ranging, monitoring, testing and tagging are selected using PCS45 software, which is loaded onto a personal computer and connected via the PCL45USB serial link- see Section 6.9.

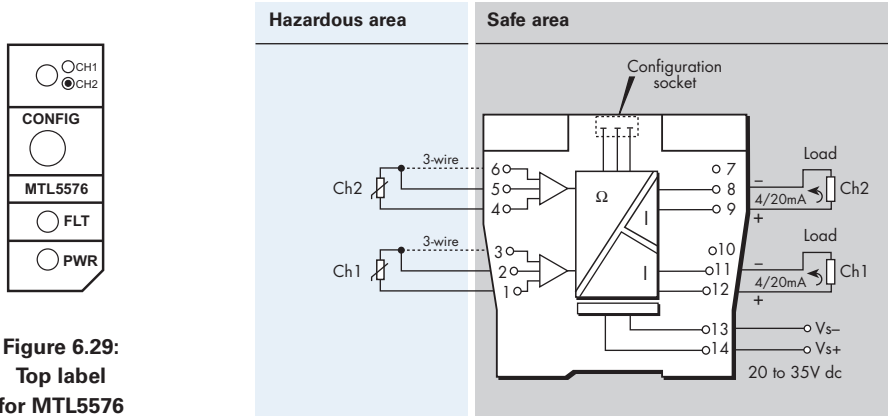

Figure 6.29:
Top label
for MTL5576

Terminal	Function
1	RTD input (Ch1)
2	RTD input (Ch1)
3	3-wire RTD input (Ch1)
4	RTD input (Ch2)
5	RTD input (Ch2)
6	3-wire RTD input (Ch2)
8	Output -ve (Ch2)
9	Output +ve (Ch2)
11	Output -ve (Ch1)
12	Output +ve (Ch1)
13	Supply -ve
14	Supply +ve

Top label

Use the following LED information to understand the module status.

Status	PWR (green)	FLT (red)	STS(yellow)
Power ON	ON		
Insufficient voltage or Power OFF	OFF		
Communication in progress	FLASH		
Normal working	ON	OFF	OFF
Device failure	ON	ON	
Channel 1 - Sensor failure/Error	ON	FLASH	OFF
Channel 2 - Sensor failure/Error	ON	FLASH	ON

Default configuration for both channels is as shown in 6.7 except S/C alarm set OFF.

6.7.4 MTL5576-THC - Temperature Converter

Two channel, mV/THC input

The MTL5576-THC converts low-level dc signals from temperature sensors mounted in a hazardous area, into 4/20mA currents for driving safe-area loads. The hazardous area connections include cold-junction compensation and do not need to be ordered separately.

Performance features, including linearisation for standard thermocouple types, ranging, monitoring, testing and tagging are selected using PCS45 software, which is loaded onto a personal computer and connected via the PCL45USB serial link- see Section 6.9.

Top label

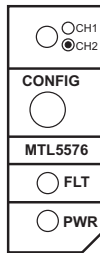
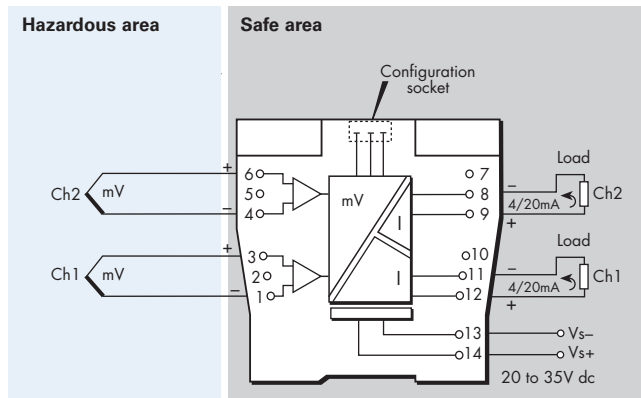

Figure 6.30:
Top label
for MTL5576



Terminal	Function
1	THC/mV (Ch1)
3	THC/mV (Ch1)
4	THC/mV (Ch2)
6	THC/mV (Ch2)
8	Output -ve (Ch2)
9	Output +ve (Ch2)
11	Output -ve (Ch1)
12	Output +ve (Ch1)
13	Supply -ve
14	Supply +ve

Use the following LED information to understand the module status.

Status	PWR (green)	FLT (red)	STS(yellow)
Power ON	ON		
Insufficient voltage or Power OFF	OFF		
Communication in progress	FLASH		
Normal working	ON	OFF	OFF
Device failure	ON	ON	
Channel 1 - Sensor failure/Error	ON	FLASH	OFF
Channel 2 - Sensor failure/Error	ON	FLASH	ON

Default configuration for both channels is as shown in 6.7 except S/C alarm set OFF.

6.7.5 MTL5581 - mV/Thermocouple Isolator

Single channel, mV/THC input for low power signals

The MTL5581 takes a low-level dc signal from a voltage source in a hazardous area, isolates it, and passes it to a receiving instrument located in the safe area. The module is intended for use with thermocouples utilising external cold-junction compensation. A switch enables or disables the safety drive in the event of thermocouple burnout or a cable breakage; a second switch permits the selection of upscale or downscale operation as the application requires.

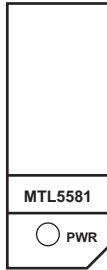
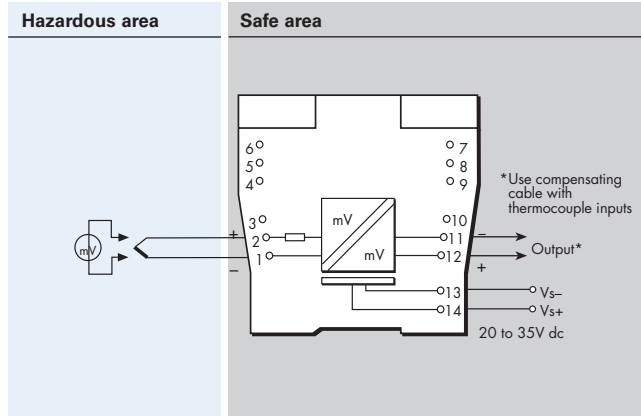

Figure 6.31:
Top label
for MTL5581



Terminal	Function
1	THC/mV input -ve
2	THC/mV input +ve
11	Output -ve
12	Output +ve
13	Supply -ve
14	Supply +ve

Please note that the safety drive on the MTL5581 responds to a line breakage (i.e. an open circuit) or a thermocouple burnout. *It does not provide detection of a short circuit.* It can however, when chosen, be set to drive the output either upscale or downscale. These options are selected using the switches located on the side of the module.

Safety drive switches		Line breakage	V _{out} value
Sw2 Safety drive	Sw1 Drive direction		
OFF	N/A	NO	V _{in} *
OFF	N/A	YES	undetermined
ON	+	NO	V _{in} *
ON	+	YES	> +50mV
ON	-	NO	V _{in} *
ON	-	YES	< -50mV

* Within V_{in}/V_{out} transfer accuracy and drift error as specified in the product datasheet.

Safety drive switches



OFF position
ON position

Sw1	OFF	ON
Drive direction	'+' Upscale	'-' Downscale

Sw2	OFF	ON
Safety drive	OFF	ON

6.7.6 MTL5582/MTL5582B - Resistance Isolator

Single channel, to repeat RTD signals

The MTL5582 or MTL5582B connect to a 2-, 3-, or 4-wire resistance temperature device (RTD) or other resistance located in a hazardous area, isolates it and repeats the resistance to a monitoring system in the safe area. The module is intended typically (but not exclusively) for use with Pt100 3-wire RTDs. Switches enable selection of 2-, 3-, or 4-wire RTD connection. The MTL5582/ MTL5582B should be considered as an alternative, non-configurable MTL5575, for use in RTD applications where a resistance input is preferred or needed instead of 4/20mA. The design is notable for its ease of use and repeatability. The number of wires which can be connected on the safe-area side of the unit is independent of the number of wires which can be connected on the hazardous-area side. The module drives upscale in the case of open circuit detection. The MTL5582B replaced the MTL5582 during 2016 to improve the response characteristics of the safe area circuit.

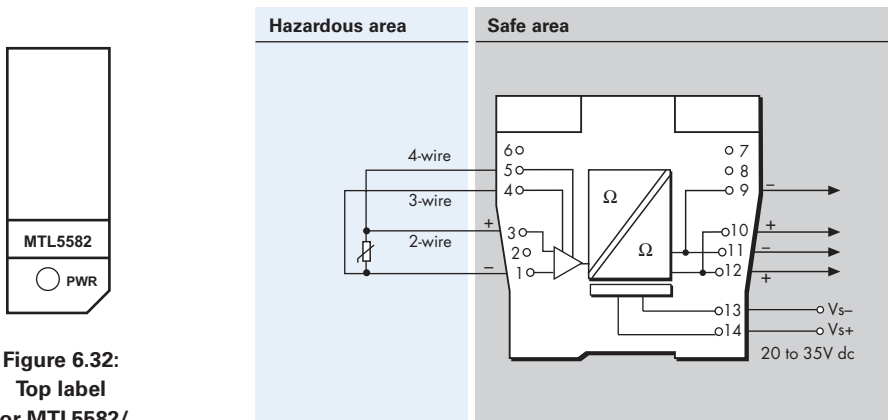
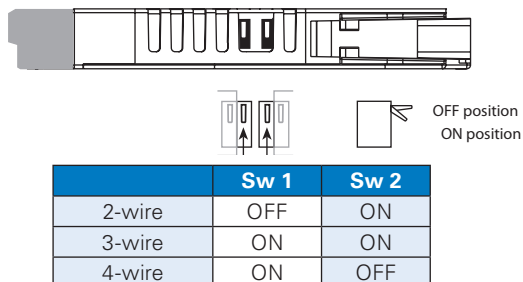

Figure 6.32:
Top label
for MTL5582/
MTL5582B

Terminal	Function
1	RTD input -ve
3	RTD input +ve
4	3-wire RTD input -ve
5	4-wire RTD input +ve
9	RTD output -ve
10	RTD output +ve
11	RTD output -ve
12	RTD output +ve
13	Supply -ve
14	Supply +ve

Warning: Check polarity of terminals used for safe-area connections. Safe-area terminals 9, 10, 11 and 12 are unipolar so it is essential to select a positive terminal on the MTL5582/MTL5582B for connection to the positive of the RTD input card.

RTD type selection switches



6.8 General modules

These are general purpose modules that have applications associated with the MTL5500 range of modules.

6.8.1 MTL5599 - Dummy Isolator

The primary function of the MTL5599, is to provide termination and earthing facilities for unused cable cores from hazardous areas, that can occur, for example, if any MTL5500 module has been removed for maintenance purposes.

6.8.2 MTL5991 - 24V dc power supply

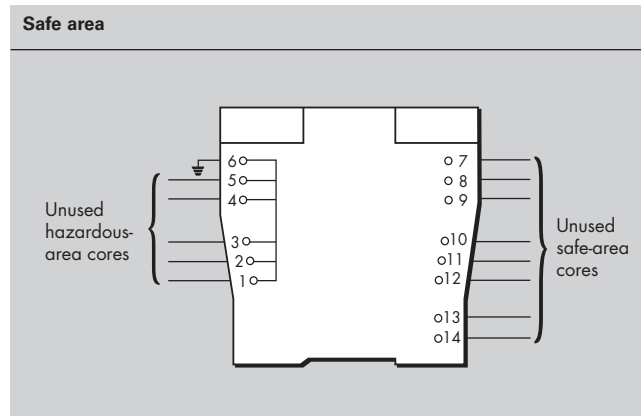

The MTL5991 provides a convenient source of power for DIN-rail mounted units in locations where a dc supply is not readily available. The wide input power supply range makes this unit universally applicable and the 2A output capability at 24V dc is sufficient to drive a useful number of MTL5500 modules- see table below. See also the MPA5500, in Section 4.2 of this manual, for powering individual modules.

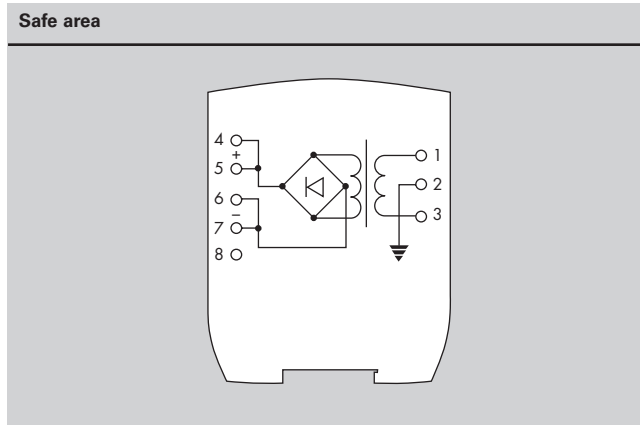

Terminal	Function
1	AC line
2	Earth
3	AC neutral
4	+24V
5	+24V
6	0V
7	0V
8	Do not use

MTL5500 unit	Current Drawn mA (Vs=24V)	Max. number of units
MTL5501-SR	90	22
MTL5510	40	50
MTL5510B	40	50
MTL5511	25	80
MTL5513	30	66
MTL5514	25	80
MTL5516C	35	57
MTL5517	35	57
MTL5521	90	22
MTL5522	125	16
MTL5523V/VL	100	20
MTL5524	100	20
MTL5525	100	20
MTL5526	44	45
MTL5531	96	20
MTL5532	65	30
MTL5533	130	15
MTL5541/S	51	39
MTL5541A/AS	45	44
MTL5544/D/S	96	20
MTL5544A/AS	70	28
MTL5546/Y	35	57
MTL5549/Y	70	28
MTL5575	50	40
MTL5576	60	33
MTL5581	30	66
MTL5582	33	60

6.9 PCS45/PCL45USB configurator for MTL temperature converters

The PCS45/PCL45USB configurator allows MTL isolating temperature converters to be configured from a standard PC running a Microsoft®Windows® operating system. The configurator comprises PC software provided on a CD (PCS45), and an ATEX certified interfacing link (PCL45USB). Temperature converters can be configured from the safe area, while on-line, and the software allows configurations to be saved to disk and printed out when required.

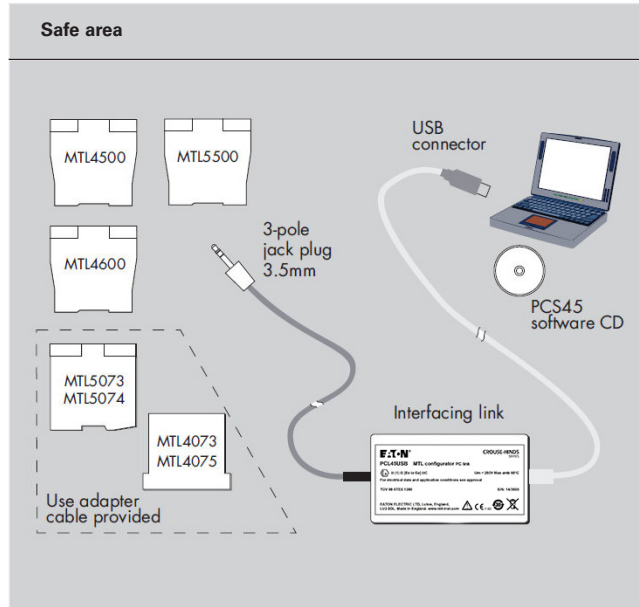

It is suitable for use with MTL4000, MTL4500, MTL5000 and MTL5500 products.

PCL45USB hardware

The PCL45USB provides the interfacing link between the converter module and the PC running the software and connects to the PC using the USB cable provided. The PCL45USB has a built-in cable fitted with a 3.5mm jackplug to connect to the 'Config' socket on MTL4500 and MTL5500 converters. An adapter cable is also provided to accommodate our earlier converters.

PCS45 Configuration software

The software provided on the CD requires only approximately 20Mb of hard disk space and is compatible with Windows 2000, Windows XP or Windows 7. Ensure that the chosen PC has a CD ROM drive and an available USB port. A local or network printer may also be an advantage.

Safety

It is not permitted to connect the PCL45USB to any device other than one approved by Eaton. Authorisation is valid provided that the converter type is named on the PCL45USB certificate or if the PCL45USB is specified on the converter certificate. Repairs to the PCL45USB are not permitted.

Setting up

The equipment can be used only in the safe area.

Before plugging in the PCL45USB link to the computer, extract the USB driver files to a known location on your PC. Afterwards, plug in the PCL45USB to the USB port on the PC and wait for it to find the new device. When requested by the computer, show it the location of the driver files so that it can complete the device installation.

Place the PCS45 software CD in the computer's CDROM drive and follow the on-screen instructions to install the software.

The PCL45USB is powered from the data lines and quickly establishes communication after plugging the 3.5mm connector to the device socket.

Note: Ensure that the 3.5mm jack plug is fully inserted into the socket of the temperature converter.

The software and its operations manual (INM PCS45) is available on-line at:

http://www.mtl-inst.com/product/configuration_tools_and_software/

7 FAULT FINDING AND ROUTINE MAINTENANCE

	<p style="text-align: center;">WARNING</p> <p style="text-align: center;">On removal, take care that a hazardous-area connector is not laid in a position in which it may inadvertently come into contact with safe-area circuit components.</p>
-----------------------------------------------------------------------------------	----------------------------------------------------------------------------------------------------------------------------------------------------------------------------------------------------------------------------------------------------------------

7.1 Maintenance precautions

Most Codes of Practice for intrinsic safety permit live maintenance on intrinsically safe devices and systems, provided precautions are taken to preserve the integrity of the device or system. During live maintenance of MTL5500 modules, the hazardous-area connectors that plug into the tops of the modules are likely to be removed. Avoid leaving a hazardous-area connector in a position where it may inadvertently contact non-IS circuits that are nearby. Prevent this by providing some form of temporary mechanical method of securing the connector so that it cannot come into contact with the non-IS circuits:

- a) By plugging the connector into an MTL5599 dummy isolator
- b) By using a tiewrap to constrain the connector in a safe position.

7.2 Fault finding

When fault finding, carry out the following steps as far as is necessary:–

7.2.1

Check that all modules with power (PWR) LEDs are ON.

With the MTL5575 & MTL5576 models, a flashing LED indicates alarm or fault conditions, refer to section 8. Note: The LED may also flash during intermediate stages of configuration.

7.2.2

Exchange potentially faulty modules for working units as follows:–

- a) Unplug the hazardous-area connectors, then the safe area connectors.
- b) Unplug any power connectors and remove from DIN rail.
- c) Reverse this procedure to fit a replacement module.

7.2.3

Potentially faulty modules should be tested in workshop conditions, using an appropriate test procedure for the particular module as described in Section 8.

7.3 Routine maintenance

Check the general condition of the installation occasionally to make sure that no deterioration has occurred. Carry out the following at least once every two years and more frequently for particularly harsh environments:–

- a) Check that modules are of the types specified in the relevant documentation.
- b) Check that modules and hazardous-area connectors are correctly and legibly tagged, that the connectors are plugged into the matching modules and that the tag details given comply with the relevant documentation.
- c) Check that hazardous- and safe-area connectors are securely plugged into their matching sockets.
- d) Check that all connections to the connectors are properly made.
- e) Check that cables to connectors are of the specified type and rating, are correctly routed and segregated (particularly in Eaton enclosures), and are not frayed or otherwise damaged.
- f) Check that cable screens are properly earthed.

Note: It is strongly recommended that only the tests (described in Section 8) and routine maintenance (described here) should be undertaken by users. If a module is faulty, DO NOT attempt to make repairs or modifications as these may affect the intrinsic safety of the module. All faulty units should be returned to the Eaton's MTL product line or representative from which they were purchased, for repair or replacement.

8 BENCH TESTING MODULES

The following methods have been devised to permit the user to perform simple module tests on the bench and confirm basic input to output operation. Field units that do not perform as described below, or modules that have 'unusual' operating behaviour, should be replaced and returned to Eaton.

Consult individual module wiring diagrams for terminal connections.

Unless stated specifically, the module will require dc power, as if under normal operating conditions.

8.1 Digital Input (DI) modules

8.1.1 Modules: MTL 5501-SR, MTL5510, MTL5510B, MTL5511, MTL5513, MTL5514, MTL5514D, MTL5516C, MTL5517

Input Conditions

1. Connect the appropriate input test circuit to the channel under test (see **Figure 8.1** & **Table 8.1**).
2. For multi-channel modules with LFD, connect a 22kΩ resistor across the other channel input(s) to prevent the signalling of an unwanted open-circuit line fault.
3. Where appropriate test with phase reversal switch in both OFF and ON conditions.

Figure 8.1:
DI input
test circuit

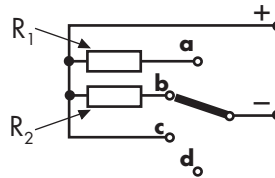

Table 8.1:
Input test
conditions

Model	Resistor values	Switch – simulation conditions
MTL5501-SR	$R_1 = 10k\Omega$, $R_2 = 1k4\Omega$	a) Normal - field switch open
MTL5510/5510B	$R_1 = 22k\Omega$, $R_2 = 680\Omega$	b) Normal - field switch closed
MTL5511		c) Line Fault - Test for short circuit
MTL5513		d) Line Fault - Test for open circuit
MTL5514/5514D		
MTL5516C		
MTL5517		

Output Results

1. For MTL5510 and MTL5510B modules refer to pages 13-15 of this manual.
2. The phase reversal switch will reverse the channel output conditions, but not the LFD.
3. With LFD disabled (OFF) the Status LED should respond as shown in Table 8.2.
4. With LFD disabled (ON) the LEDs and relay should respond as shown in Table 8.3.

Table 8.2:
Output test
results

Input switch positions	Channel contacts		Status LED
	NC	NO	
a	Closed	Open	OFF
b	Open	Closed	ON
c	Open	Closed	ON
d	Closed	Open	OFF

Input switch positions	Channel contacts		LEDs		LFD relay	
	NC	NO	Status	LFD	MTL550x	MTL551x
a	Closed	Open	OFF	OFF	Energised	De-energised
b	Open	Closed	ON	OFF	Energised	De-energised
c	Closed	Open	OFF	ON	De-energised	Energised
d	Closed	Open	OFF	ON	De-energised	Energised

8.2 Digital Output (DO) modules

Apply tests per channel.

8.2.1 Loop powered: - MTL5521, MTL5522 & MTL5525

Figure 8.2: Loop powered DO test circuit

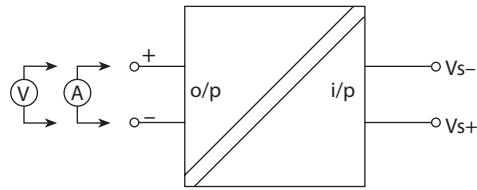

1. Connect a voltmeter between the + & - output terminals of the module, observing polarity.
2. Apply 24V between the supply terminals (Vs+, Vs-)
3. The voltmeter should indicate a value between 21.4 and 24 volts
4. Switch off the power to the module
5. Connect an ammeter between the + & - output terminals of the module, observing polarity
6. Apply 24V between the supply terminals (Vs+, Vs-)
7. The ammeter should indicate no more than 70mA for the MTL5522 and no greater than 48mA for any of the other modules
8. Switch off the power to the module

8.2.2 Powered: - MTL5523, MTL5523V, MTL5523VL & MTL5524

Figure 8.3: Powered DO test circuit

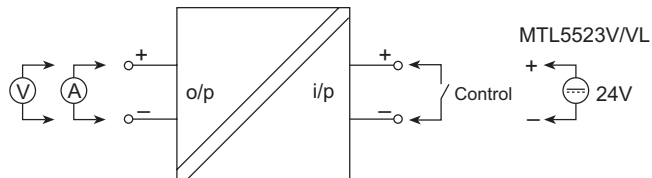

1. Connect a voltmeter between the + & - output terminals of the module, observing polarity
2. Apply 24V between the supply terminals Vs+, Vs-
3. The voltmeter should now include no more than 4V
4. Close the Control switch or, for the MTL5523V or MTL5523VL, apply the 24V source
5. The voltmeter should now indicate a value between 21.4 and 24 volts
6. Switch off the power to the module
7. Connect an ammeter between the + & - output terminals of the module, observing polarity
8. Close the Control switch or, for the MTL5523V or MTL5523VL, apply the 24V source
9. The ammeter should indicate no more than 48mA
10. Switch off the power to the module

8.2.3 Relay: - MTL5526

Figure 8.4: DO test circuit for relay type

1. Set in 2-channel mode (SW1 - SW4 respectively to Off, On, On, On)

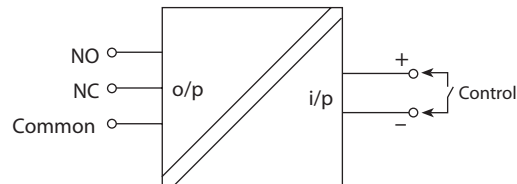

2. Confirm continuity between NC and Common
3. Apply 24V between the supply terminals Vs+, Vs-
4. Close the Control switch
5. Confirm continuity between NO and Common
6. Switch off the power to the module

8.3 Analogue Input (AI) Modules

All of these tests compare the *output* current with the *input* current (A1) over the normal range of operation, and measure the “error current” i.e. the difference- as indicated on A2. Apply these tests *per channel*, as appropriate.

Ammeter A2 must be capable of handling either polarity. If it is not an auto-ranging instrument, set it to a high range before switch on, then adjust sensitivity to obtain the required reading.

8.3.1 Modules: MTL5541, MTL5544 & MTL55544D

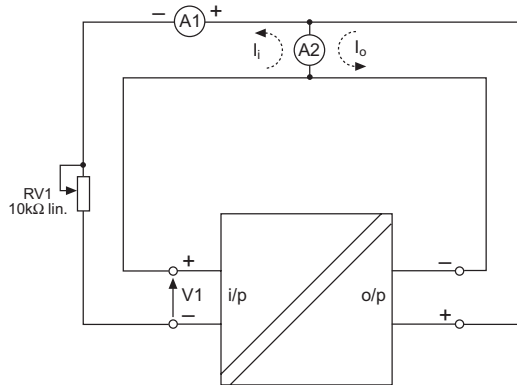

Figure 8.5: AI test circuit #1

Output Measurements

Note: Do not connect a voltmeter in circuit to measure V1 until requested in Step 4 below, because current measurement A2 could be affected.

1. Adjust RV1 to vary the current (A1) through the range 4 to 20mA
2. The measured current imbalance (A2) over this range should not exceed $\pm 20\mu\text{A}$
3. Adjust RV1 for a 20mA reading on A1
4. The voltage V1, across the channel input, should typically be $>16.5\text{V}$.

8.3.2 Modules: MTL5541S, MTL5544S & MTL5561

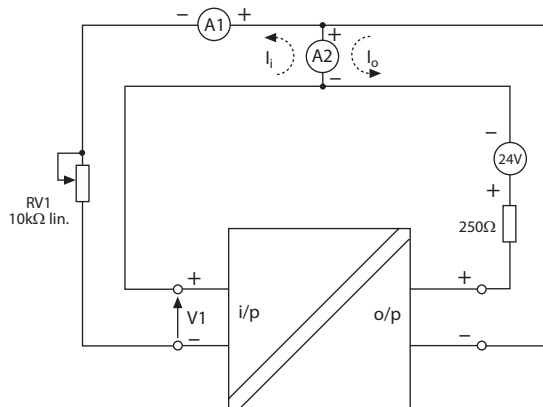

Figure 8.6: AI test circuit #2 “o/p sinking”

Output Measurements

Note: Do not connect a voltmeter in circuit to measure V1 until requested in Step 4 below, because current measurement A2 could be affected.

1. Adjust RV1 to vary the current (A1) through the range 4 to 20mA.
2. The measured current imbalance (A2) over this range for the MTL5541S and the MTL5544S should not exceed $\pm 20\mu\text{A}$. For the MTL5561 the imbalance should not exceed $\pm 400\mu\text{A}$.
3. Adjust RV1 for a 20mA reading on A1
4. The voltage V1, across the channel input, should typically be $>16.5\text{V}$.

8.3.3 Modules: MTL5541A & MTL5544A

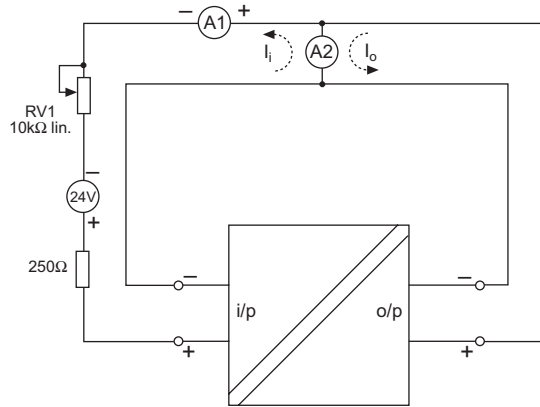

Figure 8.7: AI test circuit #3 "active i/p"

Output Measurements

1. Adjust RV1 to vary the current (A1) through the range 4 to 20mA.
2. The measured current imbalance (A2) over this range should not exceed $\pm 20\text{mA}$

8.3.4 Modules: MTL5541AS & MTL5544AS

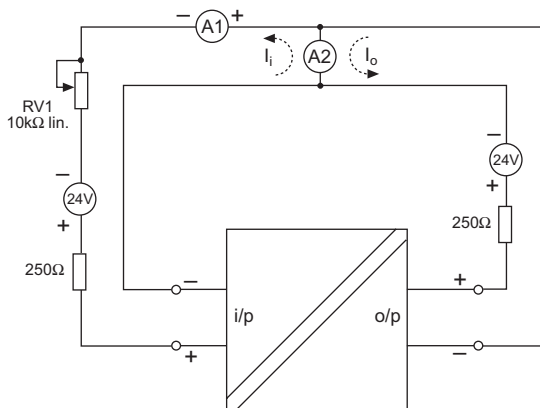

Figure 8.8: AI test circuit #4 "active i/p - o/p sinking"

Output Measurements

1. Adjust RV1 to vary the current (A1) through the range 4 to 20mA.
2. The measured current imbalance (A2) over this range should not exceed $\pm 20\text{mA}$

8.3.5 Module: MTL5581

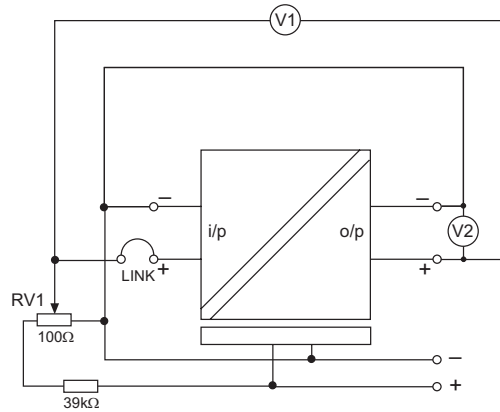

Figure 8.9: AI test circuit #5 “mV input”

Note: V1 should be capable of measurement to within 1mV.

Output Measurements

1. With the LINK connected, vary output V2 between 0 and 50mV using RV1. V1 should show <50mV variation. (Note: Safety Drive can be ON or OFF)
2. With the LINK disconnected and Safety Drive ON, V2 should drive to >+50mV with the switch set to '+', or <-50mV with the switch set to '-'.

8.3.6 Module: MTL5582

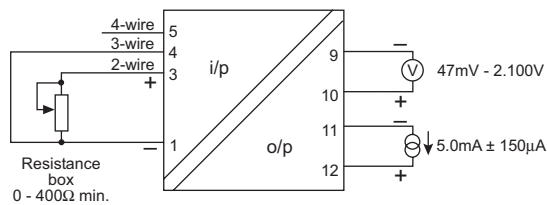

Figure 8.10: AI test circuit #5 “Resistance input”

Output Measurements

1. Set Sw1 & Sw2 to ON for 3-wire operation. Set the resistance box to any value between 10 and 400W and switch on power supply.
2. The green PWR LED should go to a steady state after initially flashing. If the flashing does not stop after 5 seconds then either the setup wiring is faulty or the unit is faulty.
3. Vary the resistance box setting between 10 and 400W and confirm the output voltage varies.
4. Short circuit the input and check that the output voltage is $\leq 51.6\text{mV}$ after 5 seconds.
5. Open circuit the input and check that the output voltage is $\leq 2.071\text{V}$ after 5 seconds and that the green PWR LED is flashing.
6. Set the input resistance to 200W and check that the output voltage settles to $1.0\text{V} \pm 32\text{mV}$

8.4 Analogue Output (AO) Modules

The test compares the output current with the input current over the normal range of operation.

8.4.1 Modules: All variants

Input Conditions

The chosen "load" resistor can be any value between 100 and 800W.

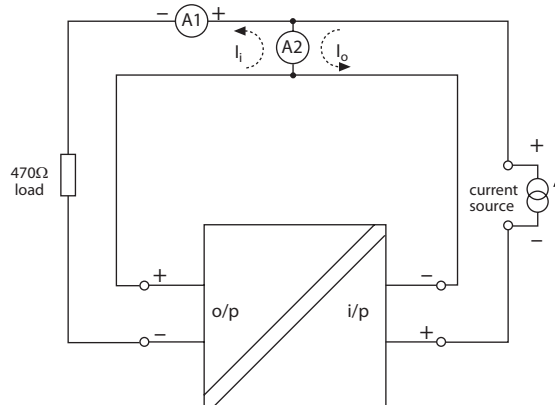

Figure 8.11: AO test circuit

Output Measurements

1. Adjust the current source to vary the current (A1) through the range 4 to 20mA.
2. The measured current imbalance (A2) over this range should not exceed $\pm 20\text{mA}$.

8.5 Testing the functioning of other modules

Simple tests to verify their basic operation can be devised for other modules (e.g. temperature, pulse, vibration, etc). If any assistance is required for the testing of a particular module, please contact the technical support department at Eaton for advice.

8.5.1 Testing

Make the safe- and hazardous-area connection shown in figure 8.12.

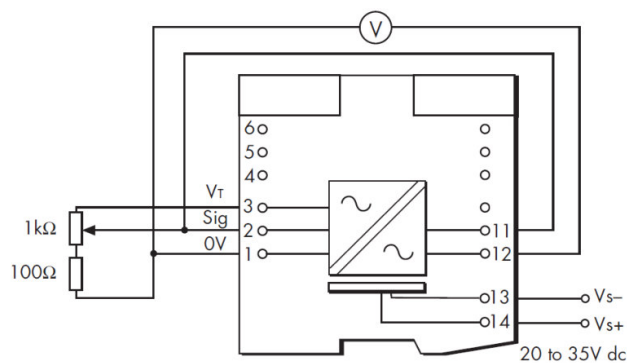

Figure 8.12: Test circuit for MTL5531

Measure the voltage on terminal 3 with respect to terminal 1; this should be $>19\text{V}$. Vary the potentiometer setting and check that the reading on voltmeter V varies by no more than $\pm 100\text{mV}$.

9 APPLICATIONS INVOLVING ZONE 2 AND/OR ZONE 22 HAZARDOUS AREAS

IMPORTANT: See page iv at the front of this manual for important additional information regarding the use of these products in countries governed by the ATEX Directive.

The European Community permits Category 3G equipment, such as the MTL5500, to be installed in, or connected to, Zone 2 flammable atmospheres provided it meets the requirements of the ATEX Directive.

MTL5500 Category 3 products have been designed to meet, and carry approval markings for, Ex nC and/or Ex nA.

In general, meeting the relevant requirements of the appropriate European (CENELEC) standards is considered the most appropriate method of demonstrating compliance with the ATEX directive. However, Eaton often has its products approved by other national bodies, such as FM and CSA and, because national, European, and international standards are converging, it is generally possible to use other national approvals as supporting evidence for the ATEX Technical File.

In the context of this document, Zone 2 (Division 2) and Zone 22 hazardous areas are those that may become potentially explosive through the presence of flammable gases, vapours and dusts for periods of up to 10 hours per year. It is recommended that the current version of the standards is consulted for detailed information on the requirements applicable to the particular installation.

As a consequence of their IS approvals, MTL5500 products *may also be connected into Zone 22* hazardous areas. Consult individual module approvals for further details.

Unless otherwise specified, the following ambient conditions apply:

Ambient Temperature range	-20°C to +60°C
Pollution Degree 2	(See EN 61010-1)
Measurement Category II	(See EN 61010-1)

9.1 Enclosure

EN 60079-15 specifies the minimum required degree of protection to be IP54, but generally this is provided by the external enclosure in which the product is mounted.

The user must refer to the specific certificates relating to the products being installed within the hazardous area to check that all special conditions of safe use have been complied with.

10 APPENDIX 1

10.1 MTL5000

Many modules in the MTL5000 Isolating Interface Units range have now been superseded by their equivalent in the MTL5500. For new applications the MTL5500 modules are recommended, these offer all the benefits of greater efficiency, new multichannel modules and new functionality.

A number of the products in the MTL5000 will continue to provide key functionality as part of MTL DIN rail isolator range and are described within this Appendix.

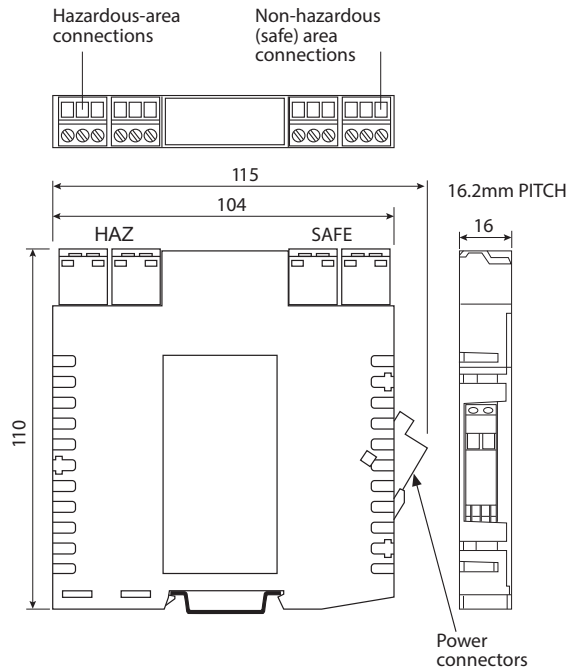

Important

- Make sure that all installation work is carried out in accordance with all relevant local standards, codes of practice and site regulations.
- When planning the installation of MTL5000 isolators it is essential to **make sure that intrinsically safe and non-intrinsically safe wiring is segregated**, and that units are installed as required by a nationally accepted authority or as described in EN 60079-14, ISA RP 12.6 or DIN VDE-165.
- Check that the hazardous-area equipment complies with the descriptive system document.
- If in doubt, refer to the certificate/catalogue for clarification of any aspects of intrinsic safety or contact Eaton's MTL product line or your local representative for assistance.
- Make sure the correct hazardous-area connector (field-wiring plug) is plugged into the corresponding isolator. It is recommended that the connector is identified by the same tag number as the matching isolator.

Mount all MTL5000 isolators on low-profile (7mm) or high-profile (15mm) type T35 (top-hat) DIN-rail to EN50022, BS5584, DIN46277. This is available from Eaton, in 1 metre lengths (**THR2**- DIN rail). Install isolators within the safe area unless they are enclosed in approved flameproof, pressurised or purged enclosures and ensure that the local environment is clean and free of dirt and dust. Note the ambient temperature considerations of section 3.1.4.

It is recommended that, in normal practice, the DIN rail should be earthed/grounded to ensure the safety of personnel in the event of a.c. mains (line) power being applied accidentally to the rail.

10.2 MTL5018AC single-pole, changeover relay, two-channel, switch/proximity detector with line fault detection and phase reversal

The MTL5018AC modules enable each of two safe-area loads to be relay-controlled by switches or proximity detectors in a hazardous area.

Line fault detection (LFD) and output phase reversal facilities are included (see section 6.1).

10.2.1 Wiring connections

See figure 10.1 for wiring connections.

Note: Reactive loads must be adequately suppressed.

10.2.2 Line fault detection

(See section 6.1 for definition of a line fault)

On each channel, input line faults (open- or short-circuit) are indicated by an LED and the de-energising of the output. LFD is enabled/disabled by switches located on the top of the module.

Note: that if the LFD facility is enabled for switch inputs, the resistors shown in 10.1 and 10.2 MUST be fitted.

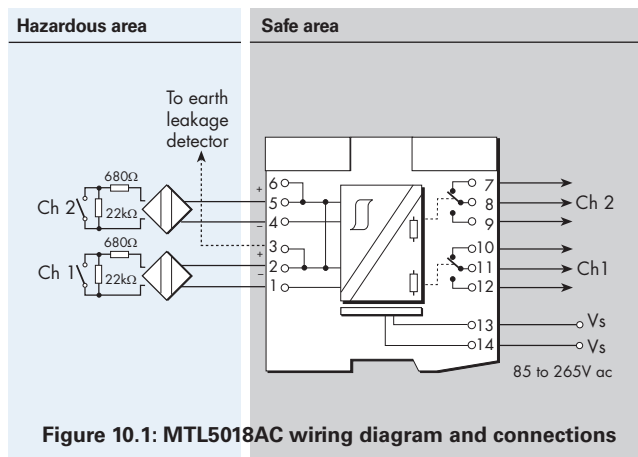

Figure 10.1: MTL5018AC wiring diagram and connections

Terminal	Function
1	Input -ve (Ch 1)
2	Input +ve (Ch 1)
3	Earth leakage detection
4	Input -ve (Ch 2)
5	Input +ve (Ch 2)
6	Earth leakage detection
7	Normally-closed contact (Ch 2)
8	Common (Ch 2)
9	Normally-open contact (Ch 2)
10	Normally-closed contact (Ch 1)
11	Common (Ch 1)
12	Normally-open contact (Ch 1)
13	Supply N
14	Supply L

10.2.3 Testing

Make the safe- and hazardous-area connections shown in figure 10.2, and check the status of the output contacts for each channel in turn (with a 22kΩ resistor connected to the other channel) as shown in the table 10.1.

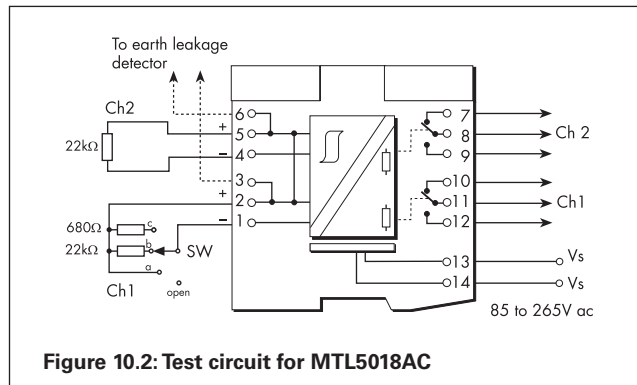

Table 10.1

Phase reverse switch	Line fault detection	Input switch (SW)	Output relay (11-12, 8-9)	Output relay (10-11, 7-8)	Channel status LED (yellow)	Line fault LED (red)
Normal	Off	a	Closed	Open	On	Off
Reverse	Off	$I_{sc} = 7 - 9\text{mA}$	Open	Closed	Off	Off
Reverse	Off	Open	Closed	Open	Off	Off
Normal	On	$V_{oc} = 7.5 - 9.5\text{V}$	Open	Closed	Off	On
Normal	On	a	Open	Closed	Off	On
Normal	On	b	Open	Closed	Off	Off
Normal	On	c	Closed	Open	On	Off

10.3 MTL5051 serial data comms isolator

The MTL5051 provides either bi-directional serial data communications from a computer system in a safe area to instrumentation in a hazardous area or data communications across a hazardous area. It is used to provide a fully floating dc supply for, and serial data communications to MTL640 text displays and MTL650 text and graphics terminals or to other IS and non-IS instrumentation and keyboards.

10.3.1 Wiring connections

See the figures 10.3 and 10.4 and the terminal specifications in tables 10.2 and 10.3 for wiring connections.

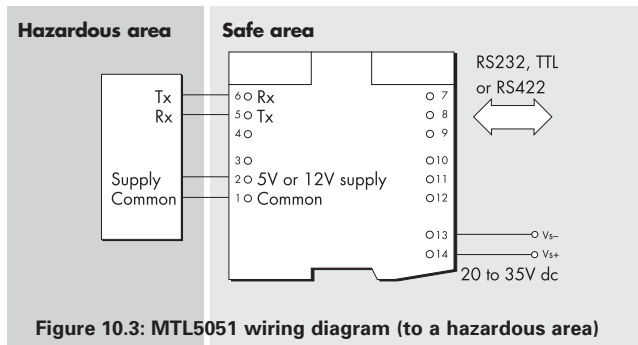

Figure 10.3: MTL5051 wiring diagram (to a hazardous area)

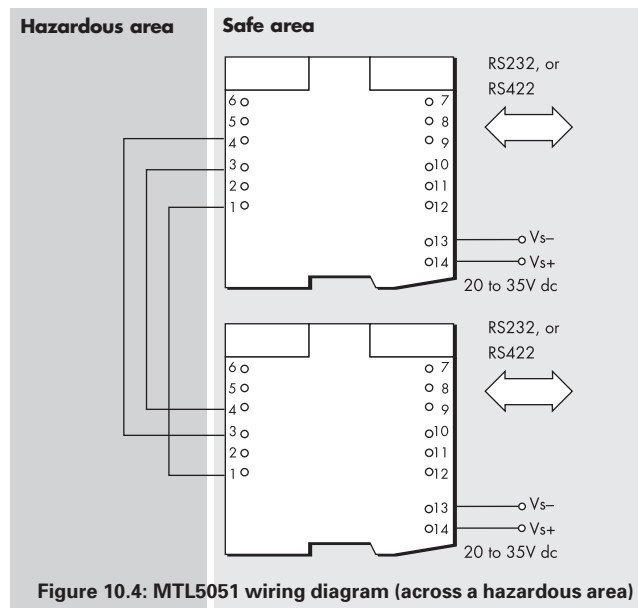

Figure 10.4: MTL5051 wiring diagram (across a hazardous area)

10.3.2 Hazardous-area interfacing

Displays/terminals: For details of interfacing with MTL640 and MTL650 displays/terminals (as an alternative to the MTL696 communications interface) see the appropriate product instruction manual.

Table 10.2

MTL5051 Terminals	MTL640 mode	MTL650 mode	Comms mode	Other IS devices
1	Common	Common	Common	Common
2	V signal	12V	-	5V/12V
3	I return	Rx	Rx	-
4	-	Tx	Tx	-
5	-	-	-	Tx
6	-	-	-	Rx
Switch				
1a	On	Off	Off	Off
1b	On	On	On	Off/On

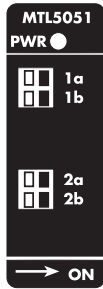

Figure 10.5:
Top label
for MTL5051

Table 10.3

Terminals	RS232 mode	TTL mode	RS422 mode
7	-	-	Rx-
8	-	-	Rx+
9	-	Tx	Tx+
10	Tx	-	Tx-
11	Common	Common	Common
12	Rx	Rx	-
13	Supply -ve	Supply -ve	Supply -ve
14	Supply +ve	Supply +ve	Supply +ve
Switch			
2a	Off	On	On
2b	On	Off	Off

Across hazardous areas: For communication across hazardous areas MTL5051 devices are used in pairs to transfer bi-directional full duplex data across hazardous areas, as shown in figure 10.4. Current switching is used to minimise the bandwidth-limiting effects of long cables. The maximum baud rate in this mode is the lesser of 19.2k baud or the cable-related rate produced by the following formula.

Remote signalling baud rate formula, for back-to-back mode across a hazardous area:

$$\text{max baud rate} = K/(R \times C \times L^2)$$

where

$$K = 0.25 \text{ (constant)}$$

$$R = \text{cable resistance } (\Omega/\text{m})$$

$$C = \text{cable capacitance (F/m)}$$

$$L = \text{length (m)}$$

For example, with a 2km cable of 100pF/m capacitance and 40mΩ/m resistance, the maximum baud rate = $0.25/(40\text{m}\Omega \times 100\text{pF} \times 2\text{km}^2) = 15\text{k}$ baud. This assumes that the cable is 2 cores plus screen, with the screen used for the 'common' connection.

RS232-level devices: Communication with RS232-level interfaces, such as a suitably certified IS keyboard, mouse, etc, is achieved by using one or more MTL5051 units as required by the IS device. (TTL level interfaces are accommodated by the TTL compatibility of RS232 receivers.) The supply to IS equipment at terminal 2 can be set to either 5V or 12V, by a switch located on top of the unit, as follows:

$$+12\text{V mode} \quad 12.0\text{V} \pm 5\% \text{ (load } < 23\text{mA)}$$

$$+12\text{V mode} \quad 8.0\text{V min (load } > 23\text{mA to } < 50\text{mA)}$$

$$+5\text{V mode } 5.6\text{V} \pm 5\% \text{ (load } > 23\text{mA to } < 50\text{mA)}$$

Note: the normal RS232 limitations of bandwidth versus cable length are applicable. As a rule of thumb, speed (baud) x length (metres) < 150,000.

10.3.3 Testing

Remove all safe- and hazardous-area connections and apply 24V dc to terminals 13 and 14 as shown in figure 10.6. Check that the green power LED (on top of the unit) is on. Put all switches in the On position. With no load, check for nominal current of 60mA \pm 5mA at terminal 14. Correct operation of the communication modes is indicated by signals received and/or transmitted.

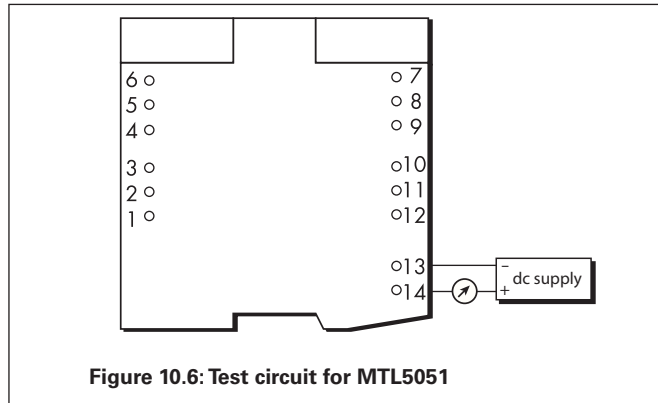

10.4 MTL5314 trip amplifier for 2- or 3- wire transmitters

The MTL5314 connects to a 2- or 3- wire 4 to 20mA transmitter or current source located in the hazardous area. It supplies one or two configurable alarm signals to the safe area via changeover relays. Each relay may be configured individually to signal an alarm condition when the input signal is greater than or less than a pre-set value.

In addition, the MTL5314 can be connected in to the hazardous area side of an MTL5042 4 to 20mA repeater power supply (or equivalent device) to provide two trip alarm outputs direct from the transmitter signal (see schematic diagram). Looping the transmitter signal through the MTL5314 (via terminals 1 and 3) does not affect HART® communications.

Terminals 1 and 3 meet clause 5.4 of EN50020: 1994 and have the following parameters:
 $U \leq 1.5V$, $I \leq 0.1A$, $P \leq 25mW$. They can be connected without further certification into an IS loop with open circuit voltage of not more than 28V. See certificate for further details.

10.4.1 Wiring connections

If terminals 1 and 3 provide a 4 to 20mA loop to a HART transmitter, HART communication can be superimposed on the 4 to 20mA signal.

Note: Reactive loads must be adequately suppressed.

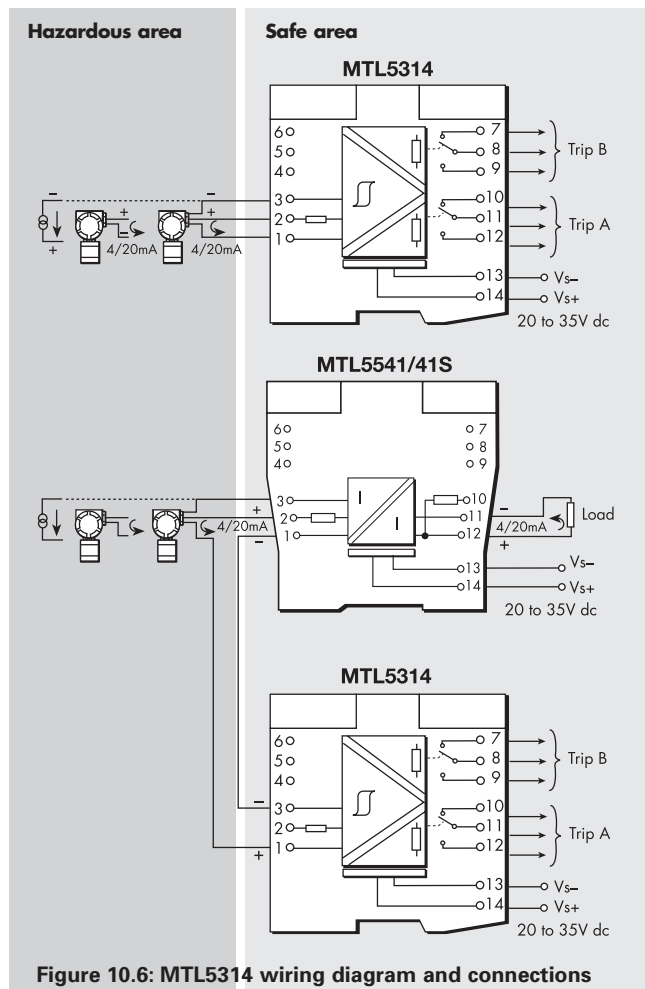

Terminal	Function
1	Current input
2	Transmitter supply +ve
3	Common
7	Trip B (NC)
8	Trip B (COM)
9	Trip B (NO)
10	Trip A (NC)
11	Trip A (COM)
12	Trip A (NO)
13	Supply -ve
14	Supply +ve

10.4.2 Trip calibration

Switches and multiturn potentiometers for setting the trip points are located on top of the unit (see figure 10.7). For each of channels A and B:

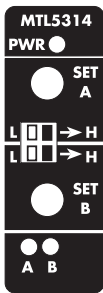

Figure 10.7:
Top label
for MTL5314

- i Set trip switch to H (high) or L (low) as required (see table 10.4 for relay operation).
- ii Set input current to the required value for trip-point.
- iii Adjust SET A/SET B until LED A/B is on: then slowly adjust until LED goes out.
- iv Relays are energised in normal operation and de-energised when tripped. A lit LED shows the safe condition (not tripped).

Table 10.4

Trip switch A or B	Operation	PWR LED	A or B LED	Relay contacts	
				11 - 12 8 - 9	10 - 11 7 - 8
H (high)	Input > trip setting	☆	•	open	closed
H (high)	Input < trip setting	☆	☆	closed	open
L (low)	Input > trip setting	☆	☆	closed	open
L (low)	Input < trip setting	☆	•	open	closed
-	-	•	•	open	closed

10.4.3 Testing

Make the safe- and hazardous-area connections shown in figure 10.7 and carry out the following procedure:

- a Set the current source or sink to 12mA
- b Adjust each trip potentiometer until the associated LED just extinguishes.
- c With sources of 11.5mA and 12.5mA carry out the following checks:

Table 10.5

Current	High alarm Relay			Low alarm Relay		
	LED	11 - 12 8 - 9	10 - 11 7 - 8	LED	11 - 12 8 - 9	10 - 11 7 - 8
11.5mA	On	closed	open	Off	open	closed
12.5mA	Off	open	closed	On	closed	open

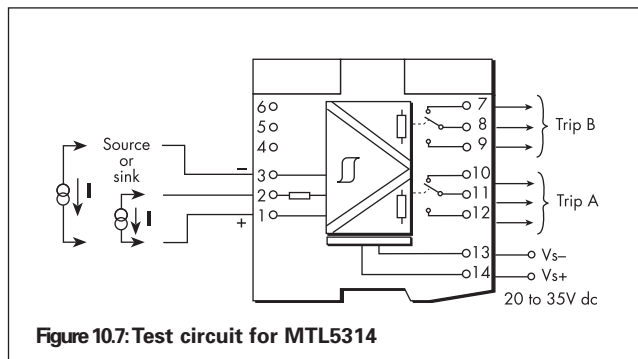

APPENDIX 2:

Table A - Safety descriptions

Model No.	Terminals/ Bornes/Klemme/ Terminales	U _o (V)	I _o (mA)	P _o (mW)
MTL5501-SR		±9.7	30	70
MTL5510		10.5	14	37
MTL5510B		10.5	14	37
MTL5511		10.5	14	37
MTL5513		10.5	14	37
MTL5514		10.5	14	37
MTL5514D		10.5	14	37
MTL5516C		10.5	14	37
MTL5517		10.5	14	37
MTL5521		25	147	920
MTL5522		25	166	1040
MTL5523		25	147	920
MTL5523V		25	147	920
MTL5523VL		25	108	680
MTL5524		25	147	920
MTL5525		25	83.3	521
MTL5526	1 ⇔ 3, 4 ⇔ 6	Non-energy storing *		
MTL5531	3 ⇔ 1	26.6	94	660
	3 ⇔ 2	1.1	0.1	0.03
MTL5532	2 ⇔ 1, 6 ⇔ 1	10.5	14	37
	3 ⇔ 1	1.1	53	15
	4 + 3 ⇔ 1	28	93 @ 28V 146 @ 2.9V	650
	5 + 4 ⇔ 1	28	93	650
	config †	U _o = 7.2 U _i = 9.1	15	27
MTL5533	3 ⇔ 1, 6 ⇔ 4	26.6	94	660
	3 ⇔ 2, 6 ⇔ 5	1.1	0.1	0.03
MTL5541		28	93	651
MTL5541A		8.6	-	-
MTL5541AS	(diode)			
MTL5541S		28	93	651
MTL5544		28	93	651
MTL5544A		8.6	-	-
MTL5544AS	(diode)			
MTL5544D		28	93	651
MTL5544S		28	93	651
MTL5546		28	93	651
MTL5546Y		28	93	651
MTL5549		28	93	651
MTL5549Y		28	93	651
MTL5561		28	93	651
MTL5573	1+2+3+4+5+6	6.6	76	130
	3 ⇔ 1	Non-energy storing *		
	3,2 & 1	6.6	10	17
MTL5575	config †	U _o = 8 U _i = 9.1	14.6	26
	1+2+3+4+5+6	6.6	76	130
MTL5576	1,2 & 3, 4,5,& 6	6.6	28	46.2
	3 ⇔ 1, 6 ⇔ 4	Non-energy storing *		
	config †	U _o = 5.88 U _i = 9.1	12	17.7
MTL5581		U _o = 1.1 U _i = 28	I _o = 53 I _i = 120	15
MTL5582	1,3,4 & 5	6.6	42	69.3
	3 ⇔ 1	Non-energy storing *		
	1,3, & 4	6.6	28	46.2
MTL5582	config †	U _o = 5.88 U _i = 9.1	12	17.7

Table B - Maximum cable parameters - IIC gas group

Model No.	Terminals/ Bornes/ Klemme/ Terminales	Group/Groupe/Gruppe/Grupo IIC		
		C (µF)	L (mH)	L/R (µH/Ω)
MTL5501-SR		3.5	39	475
MTL5510		2.41	175	983
MTL5510B		2.41	175	983
MTL5511		2.41	175	983
MTL5513		2.41	175	983
MTL5514		2.41	175	983
MTL5514D		2.41	175	983
MTL5516C		2.41	175	983
MTL5517		2.41	175	983
MTL5521		0.11	1.4	40
MTL5523		0.11	1.4	40
MTL5523V		0.11	1.4	40
MTL5523VL		0.11	3.04	52
MTL5524		0.11	1.4	40
MTL5525		0.11	1.4	40
MTL5526		Non-energy storing *		
MTL5531	3 ⇔ 1	0.094	4.02	56
	3 ⇔ 2	100	1,000	1,000
MTL5532	2 ⇔ 1, 6 ⇔ 1	2.41	181	967
	3 ⇔ 1	100	12.6	2,439
	4 + 3 ⇔ 1	0.083	1.66	55
	5 + 4 ⇔ 1	0.083	4.02	55
	config †	0.433	60.7	360
MTL5533	3 ⇔ 1, 6 ⇔ 4	0.094	4.02	56
	3 ⇔ 2, 6 ⇔ 5	100	1,000	1,000
MTL5541	2 ⇔ 1, 5 ⇔ 4	0.083	4.2	56
	3 ⇔ 1, 6 ⇔ 4	100	12.8	2,438
	2 ⇔ 3, 5 ⇔ 6	0.083	5.0	59
MTL5541A		6.2	5.01	1351
MTL5541AS		6.2	5.01	1351
MTL5544A		6.2	5.01	1351
MTL5544AS		6.2	5.01	1351
MTL5546		0.083	4.2	56
MTL5546Y		0.083	4.2	56
MTL5549		0.083	4.2	56
MTL5549Y		0.083	4.2	56
MTL5561		0.083	4.2	56
MTL5573	1+2+3+4+5+6	22	6.42	288
	config †	0.367	153	349
MTL5575	1+2+3+4+5+6	22	6.42	288
	config †	0.433	153	349
MTL5576	1,2 & 3, 4,5,& 6	11	22.6	384
	3 ⇔ 1, 6 ⇔ 4	50	500	1666
	config †	0.58	0079.4	448
MTL5581		100	12.8	2,438
MTL5582	1,3,4 & 5	22	20.1	513
	3 ⇔ 1	100	1,000	3,300
	1,3, & 4	22	45.3	769
MTL5582	config †	0.58	79.4	448

Table C - Maximum cable parameters - IIB gas group

Model No.	Terminals/ Bornes/ Klemme/ Terminales	Group/Groupe/Gruppe/Grupo IIB		
		C (µF)	L (mH)	L/R (µH/Ω)
MTL5522		0.84	5.6	132

* Appareil ne stockant pas d'energies / Betriebsmittel ohne Energiespeicherung / Aparatos que no almacenan energia (≤ 1,5V; ≤ 0,1A; ≤ 25mW)

† config configuration socket / fiche de configuration / konfigurationssocket / toma con configuración

This page left intentionally blank

This page left intentionally blank

This page left intentionally blank

AUSTRALIA

MTL Instruments Pty Ltd,
10 Kent Road, Mascot, New South Wales, 2020, Australia
Tel: +61 1300 308 374 Fax: +61 1300 308 463
E-mail: mtl-salesanz@eaton.com

BeNeLux

MTL Instruments BV
Ambacht 6, 5301 KW Zaltbommel
The Netherlands
Tel: +31 (0)418 570290 Fax: +31 (0)418 541044
E-mail: mtl.benelux@eaton.com

CHINA

Cooper Electric (Shanghai) Co. Ltd
955 Shengli Road, Heqing Industrial Park
Pudong New Area, Shanghai 201201
Tel: +86 21 2899 3817 Fax: +86 21 2899 3992
E-mail: mtl-cn@eaton.com

FRANCE

MTL Instruments sarl,
7 rue des Rosieristes, 69410 Champagne au Mont d'Or
France
Tel: +33 (0)4 37 46 16 53 Fax: +33 (0)4 37 46 17 20
E-mail: mtlfrance@eaton.com

GERMANY

MTL Instruments GmbH,
Heinrich-Hertz-Str. 12, 50170 Kerpen, Germany
Tel: +49 (0)22 73 98 12-0 Fax: +49 (0)22 73 98 12-2 00
E-mail: csckerpen@eaton.com

INDIA

MTL India,
No.36, Nehru Street, Off Old Mahabalipuram Road
Sholinganallur, Chennai- 600 119, India
Tel: +91 (0) 44 24501660 /24501857 Fax: +91 (0) 44 24501463
E-mail: mtlindiasales@eaton.com

ITALY

MTL Italia srl,
Via San Bovio, 3, 20090 Segrate, Milano, Italy
Tel: +39 02 959501 Fax: +39 02 95950759
E-mail: chmninfo@eaton.com

JAPAN

Cooper Crouse-Hinds Japan KK,
MT Building 3F, 2-7-5 Shiba Daimon, Minato-ku,
Tokyo, Japan 105-0012
Tel: +81 (0)3 6430 3128 Fax: +81 (0)3 6430 3129
E-mail: mtl-jp@eaton.com

NORWAY

Norex AS
Fekjan 7c, Postboks 147,
N-1378 Nesbru, Norway
Tel: +47 66 77 43 80 Fax: +47 66 84 55 33
E-mail: info@norex.no

RUSSIA

Cooper Industries Russia LLC
Elektrozavodskaya Str 33
Building 4
Moscow 107076, Russia
Tel: +7 (495) 981 3770 Fax: +7 (495) 981 3771
E-mail: mtlrussia@eaton.com

SINGAPORE

Cooper Crouse-Hinds Pte Ltd
No 2 Serangoon North Avenue 5, #06-01 Fu Yu Building
Singapore 554911
Tel: +65 6645 9864 / 6645 9865 Fax: +65 6 487 7997
E-mail: sales.mtlsing@eaton.com

SOUTH KOREA

Cooper Crouse-Hinds Korea
7F, Parkland Building 237-11 Nonhyun-dong Gangnam-gu,
Seoul 135-546, South Korea.
Tel: +82 6380 4805 Fax: +82 6380 4839
E-mail: mtl-korea@eaton.com

UNITED ARAB EMIRATES

Cooper Industries/Eaton Corporation
Office 205/206, 2nd Floor SJ Towers, off. Old Airport Road,
Abu Dhabi, United Arab Emirates
Tel: +971 2 44 66 840 Fax: +971 2 44 66 841
E-mail: mtlgulf@eaton.com

UNITED KINGDOM

Eaton Electric Ltd,
Great Marlings, Butterfield, Luton
Beds LU2 8DL
Tel: +44 (0)1582 723633 Fax: +44 (0)1582 422283
E-mail: mtlenquiry@eaton.com

AMERICAS

Cooper Crouse-Hinds MTL Inc.
3413 N. Sam Houston Parkway W.
Suite 200, Houston TX 77086, USA
Tel: +1 281-571-8065 Fax: +1 281-571-8069
E-mail: mtl-us-info@eaton.com